



Elliptical Owner's Manual

intenza

Intenza Elliptical 550ETXe2

Intenza Elliptical 550ETXi

Designed to inspire. ©Intenza 2018. All rights reserved.

Welcome To Intenza

Thank you for purchasing our Intenza 550 Series Elliptical.

Since Intenza Fitness first launched its line in 2012, our compelling designs, innovation and energy efficiency have garnered multiple awards. Designed to inspire, your future is bright. Exciting, and full of promise. It is our pleasure to join you on your fitness journey.

Before installing or using the equipment, please read all instructions in the documentation provided with this equipment. Always follow basic safety precautions when installing and using this equipment. This manual will provide guidelines for quick set up and the correct way to use the equipment. We hope your experience with this product allows you to achieve your fitness goals and meets your expectations.

The individual human power which is required to carry out an exercise can be different than the mechanical power displayed. A warning notice to the effect that the safety level of the equipment can be maintained only if it is examined regularly for damage and wear, e.g. ropes, pulleys, connection points.

The Intenza 550 Series Elliptical has been tested and designed to comply with the regulations for a Class A digital device and for Class S studio use pursuant to part 15 of the FCC rules and UL regulations. This equipment is in compliance with European Directives, ie. Machinery Directive 2006/42/EC and Low Voltage Directive 2006/95/EC. The Intenza 550 Series Elliptical is designed to provide you with a safe, intuitive, comfortable and reliable experience, guiding you to a healthy lifestyle.

FCC Warning Possible Radio/Television Interference

CAUTION Any changes or modifications to this equipment will affect the product warranty.



Table of Contents

1	IMPORTANT SAFETY INSTRUCTIONS AND PRECAUTIONS	4
2	INTENZA 550 SERIES ELLIPTICAL OVERVIEW AND ASSEMBLY	6
2.1	550ETXe2 overview	8
2.2	550 ETXi overview	9
2.3	550ETXe2 & 550 ETXi Part List	10
2.4	550ETXe2 & 550 ETXi Assembly Instructions	13
2.5	Safety Space	18
3	HOW TO USE INTENZA 550 SERIES ELLIPTICAL	19
3.1	550ETXe2 Entertainment Console Overview	20
3.2	550ETXe2 Entertainment and Media Operation	21
3.2.1	550ETXe2 Entertainment And Media Operation: TV	22
3.2.2	550ETXe2 Entertainment And Media Operation: Intenzacast	23
3.2.3	550ETXe2 Entertainment And Media Operation: Internet	25
3.2.4	550ETXe2 Entertainment And Media Operation: Audio/Video	26
3.2.5	550ETXe2 Entertainment And Media Operation: Virtual Scenery	27
3.2.6	550ETXe2 Entertainment And Media Operation: YouTube	28
3.2.7	550ETXe2 Entertainment And Media Operation: HDMI Input	29
3.3	550ETXi Interactive Console Overview	30
3.4	How To Effectively Workout At Your Own Level	32
3.5	How to Personalize Your Workout	33
3.6	Save the Workout Profile	34
3.7	How To Track Your Workout Record	35
3.8	Setting of 550 Elliptical	38
3.9	Begin The Workout	40
4	WORKOUT OPTIONS	41
4.1	Quick Start	41
4.2	Preset Program	42

4.3	Target Program	45
4.4	HRC Program	48
4.5	Custom Program	52
5.6	Race Program	54
4.7	Fitness Test	58
5	MAINTENANCE	62
5.1	Preventative Maintenance Tips	62
5.2	Self Diagnosis	63
5.3	How to Charge The Battery	63
5.4	Recycling The Battery	63
6	TROUBLESHOOTING	64
6.1	When To Call For Help	64
6.2	Error Message	64
7	EXPLODED DRAWING & PART LIST AND SPECIFICATIONS	65
7.1	550ETXe2 Exploded Drawing and Parts List	65
7.2	550ETXi Exploded Drawing and Parts List	67

IMPORTANT SAFETY INSTRUCTIONS

When using an electrical appliance, basic precautions should always be followed, including the following:
Read all instructions before operation.

WARNING

- The 550 Series Elliptical is designed for aerobic exercise in a commercial or consumer environment.
- Please check with your physician prior to beginning any exercise program.
- Heart rate monitoring systems may be inaccurate. Over exercise may result in serious injury or death. If you feel faint stop exercising immediately.
- Stop exercising immediately and consult a physician if you feel any abnormal symptoms such as fainting, dizziness, chest pain, nausea or shortness of breath.

DANGER

- Make sure all users see a physician for a complete physical examination before they begin any fitness program.
- Unsupervised children must be kept away from this equipment.
- Assemble and operate the equipment on a solid level surface.
- Set the equipment a few feet away from walls or furniture, and away from sources of heat, such as radiators, heat registers and stoves. Avoid extreme temperature changes.
- Do not place outdoors or in an enclosed swimming pool environment.
- Keep hands and loose clothing away from moving parts.
- Keep equipment away from water and moisture. Avoid dropping or spilling anything on/inside the equipment to prevent electric shock, or damage to the equipment.
- Never leave the equipment unattended when it is plugged in. Unplug the equipment from its power source when it is not in use.
- The optional power adapter is considered a power source for self-powered equipment. Always unplug this equipment from the electrical outlet immediately after use or before cleaning.
- Keep the optional power adapter and plug away from heated surfaces.
- Do not insert any object into any opening, or underneath the equipment.
- Do not attempt to remove the cover or modify the equipment. Service should only be conducted by an authorized service technician.
- Wear shoes with rubber or high-traction soles. Do not wear shoes with heels, leather soles, cleats or spikes.
Make sure no stones are embedded in the soles.
- Do not use the equipment with bare feet.

SAVE THESE INSTRUCTIONS

WARNING

Connect this appliance to a properly grounded outlet only.
See Grounding Instructions.

GROUNDING INSTRUCTIONS

This product must be grounded. If it should malfunction or breakdown, grounding provides a path of least resistance for electric current to reduce the risk of electric shock. This product is equipped with a cord with an equipment—grounding conductor and a grounding plug. The plug must be plugged into an appropriate outlet that is properly installed and grounded in accordance with all local codes and ordinances.

This product is connected to **12V 80W** adaptor which is **6.67A** and is for use on a circuit having a nominal rating of **100—240 V** and is factory—equipped with a specific electric cord and plug to permit connection to a proper electric circuit. Make sure that the product is connected to an outlet having the same configuration as the plug. If the product must be reconnected for use on a different type of electric circuit, reconnection must be made by qualified service personnel.

DANGER

Improper connection of the equipment—grounding conductor can result in risk of electric shock. Check with a qualified electrician if you are in doubt as to whether the product is properly grounded. Do not modify the plug provided with the product— if it will not fit the outlet, have a proper outlet installed by a qualified electrician.

2. Intenza 550 Series Elliptical Overview And Assembly

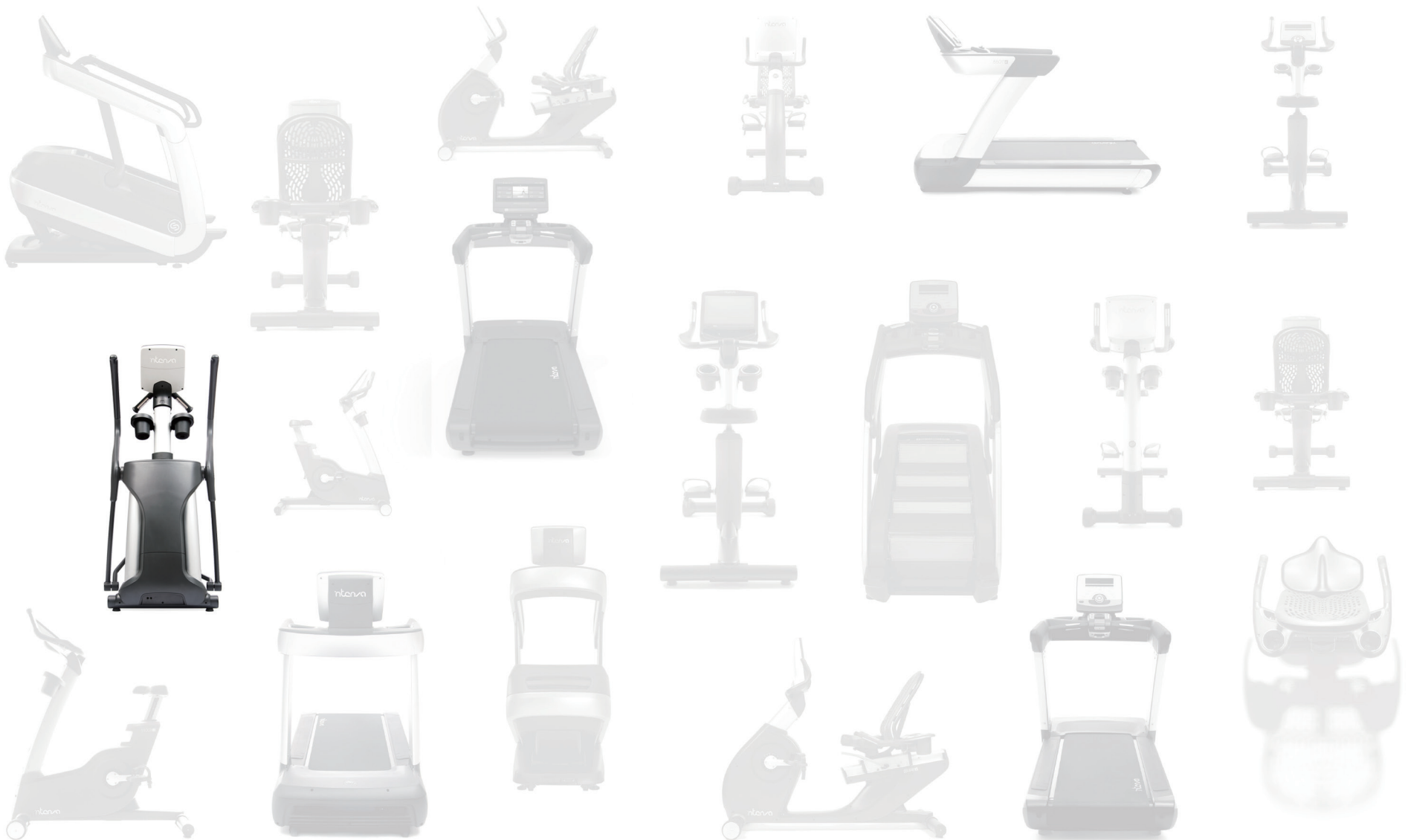

Important Safety Precautions

SAFETY PRECAUTIONS

- Unsupervised children must be kept away from this equipment.
- Assemble and operate the equipment on a stable base which is properly leveled.
- Keep an open area of 3 feet by 3 feet (1000 mm x 1000 mm) behind the Elliptical clear of any obstructions including walls, furniture and other equipment.
- Keep away from sources of heat such as radiators, heat registers and stoves. Avoid extreme temperature changes.
- Do not use outdoors or in an enclosed swimming pool environment.
- Keep equipment away from water and moisture. Avoid dropping anything on or spilling anything inside the equipment to prevent electric shock or damage the electronics.
- Never leave the equipment unattended when it is plugged in. Unplug the equipment from its power source when it is not in use for a long time.
- Do not drop or insert any object, hands, or feet into any opening, or underneath the equipment.
- Do not attempt to remove the cover or modify the equipment. Service should only be done by an authorized service technician.
- Do not use the equipment with bare feet. Wear shoes with rubber or high—traction soles. Do not use shoes with heels, leather soles, cleats or spikes. Make sure no stones are embedded in shoe soles.
- Do not operate the equipment until the defective components are repaired.
- Use the handrails whenever additional stability is required. In case of emergency, such as tripping, the user should grab the handrails.

2.1 550ETXe2 Overview



2.2 550ETXi Overview



2.3 550ETXe2 & 550ETXi Parts List

Open the shipping carton. Remove all parts from the carton and cardboard inserts.

Before beginning assembly, verify that the following hardware items are packed with the equipment. Do not attempt to move the equipment off the pallet by yourself. At least two people are required for safe moving or lifting. Please use safe lifting techniques. Please use hex wrench (3mm, 5mm, 6mm) and open wrench (13mm) to assemble the Elliptical.

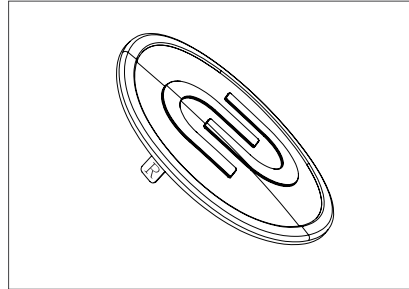

1. Right bug

QTY 1

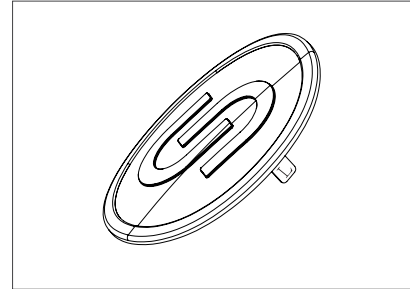

2. Left bug

QTY 1

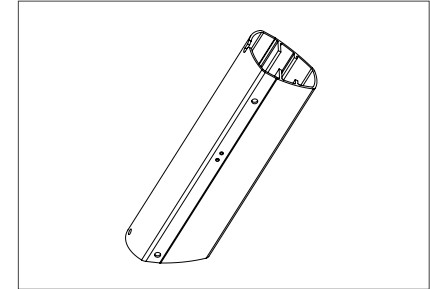

3. Front post

QTY 1

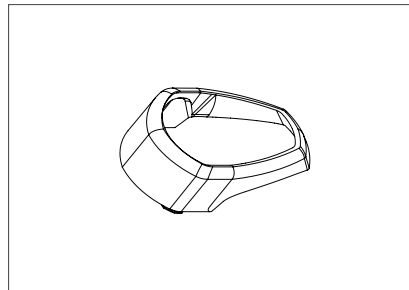

4. Front post cover

QTY 1

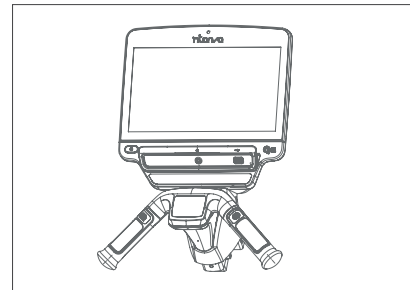

5. Console for 550 ETXe2

QTY 1

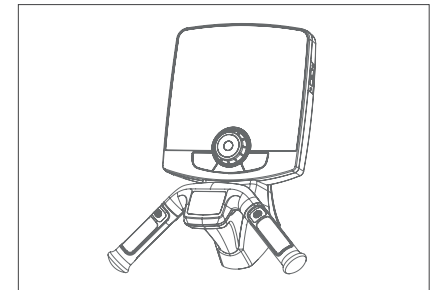

6. Console for 550 ETXi

QTY 1

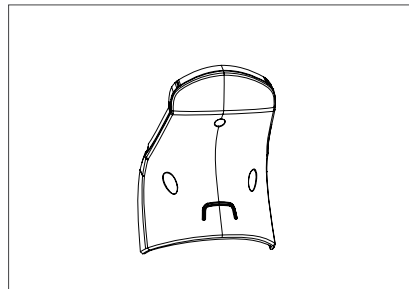

7. Console cover for ETXe2

QTY 1

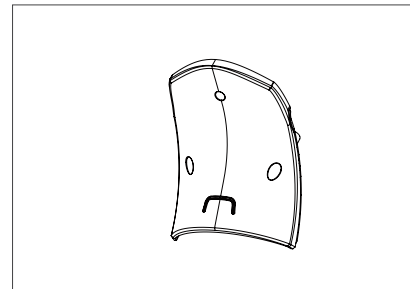

8. Console cover for ETXi

QTY 1

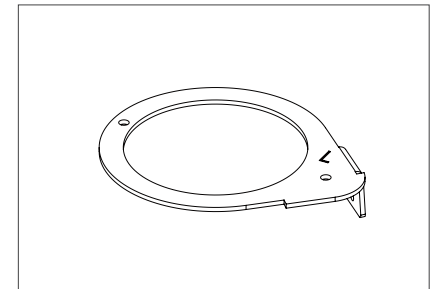

9. Left cup holder bracket

QTY 1

2.3 550ETXe2 & 550ETXi Parts List

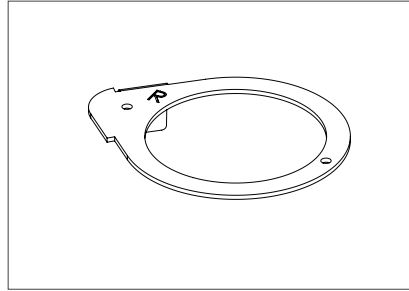

10. Right cup holder bracket

QTY 1

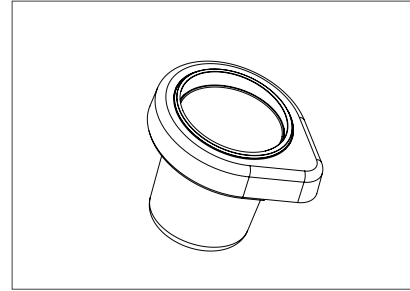

11. Cup holder

QTY 2

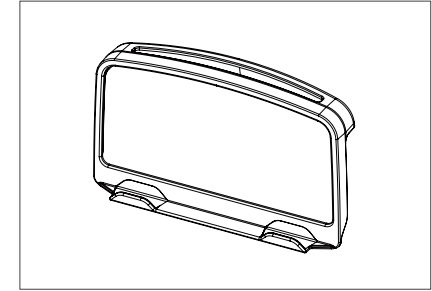

12. iPad rack for ETXi

QTY 1

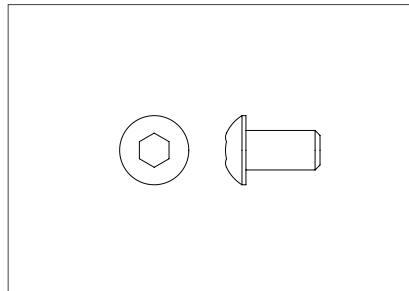

13. Dome screw, M8 x 15L

QTY 5

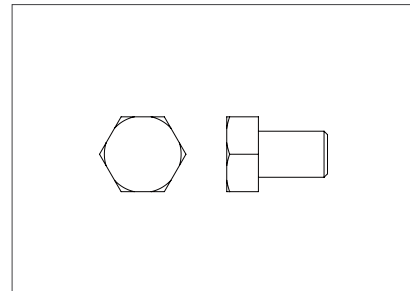

14. Hex bolt, M8 x 10L

QTY 3

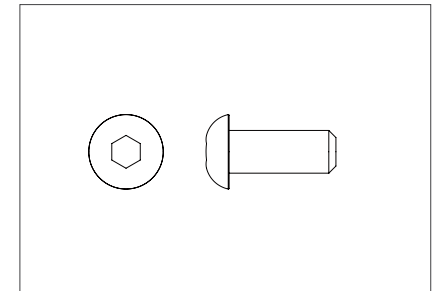

15. Dome screw, M6 x 15L

QTY 8

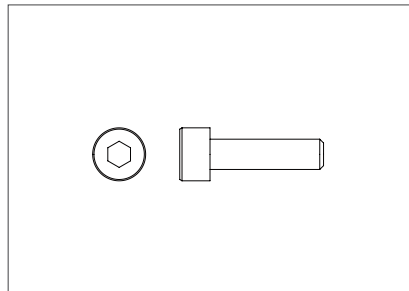

16. Tapping screw, M4 x 15L

QTY 3

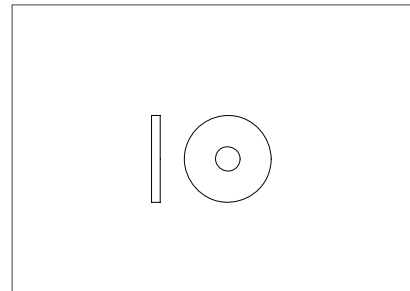

17. Washer, M8

QTY 2

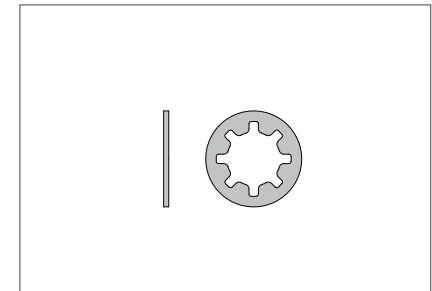

18. Star washer, Black, M8

QTY 3

2.3 550ETXe2 & 550ETXi Parts List

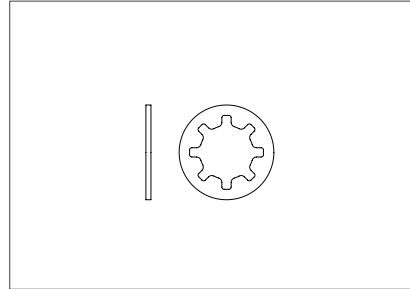

19. Star washer, White, M8

.....
QTY 3
.....

2.4 550ETXe2 & 550ETXi Assembly Instructions

STEP 1

Assemble the right handle bar.

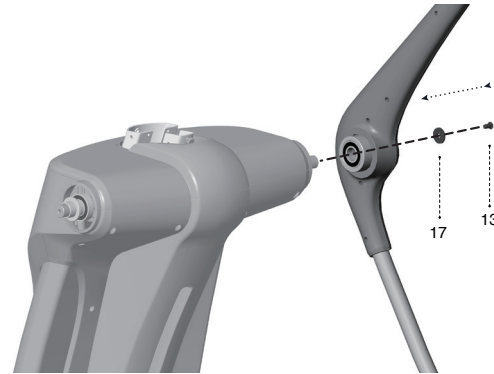

PLEASE NOTE

Align the handle bar to the pivot point.

COMPONENTS AND TOOLS

Dome screw, M8 x 15L(17), Washer, M8(13)

Hex wrench— 6mm

STEP 2

Assemble the left handle bar.

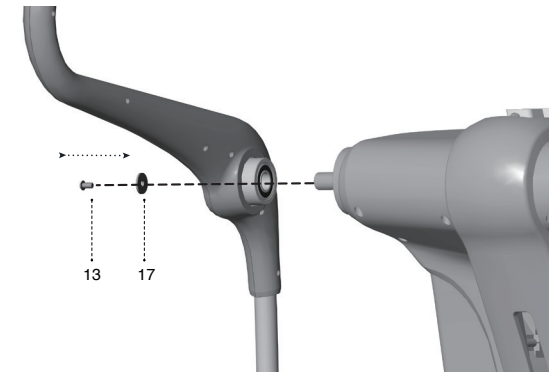

PLEASE NOTE

Align the handle bar to the pivot point.

COMPONENTS AND TOOLS

Dome screw, M8 x 15L(17), Washer, M8(13)

Hex wrench— 6mm

STEP 3

Assemble the bug cap.

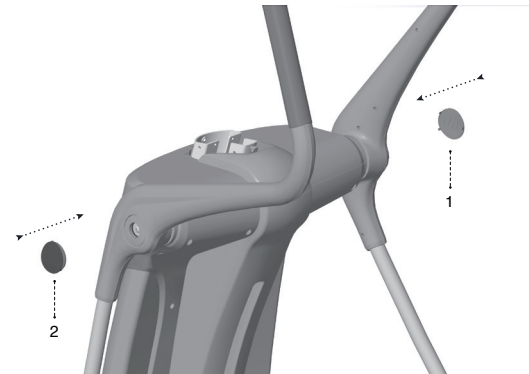

PLEASE NOTE

Identify the Right and Left side bug caps as shown above.

Remove adhesive protective cover from the back of the bug cap. Attach the cap to the handlebar.

STEP 4

Assemble the front post.

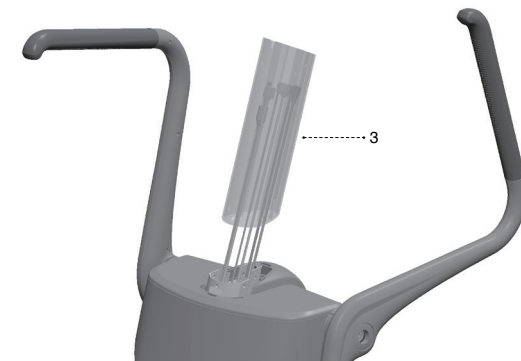

PLEASE NOTE

Make sure the cables are not pinched during front post installation.

2.4 550ETXe2 & 550ETXi Assembly Instructions

STEP 5

Assemble the front post.

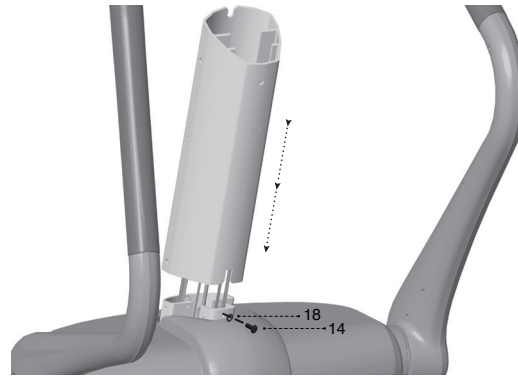

PLEASE NOTE

Screw #14 and washer #18 as shown, are pre-assembled and will need to be properly tightened during the front post installation. Refer to step 6.

COMPONENTS AND TOOLS

Star washer, Black, M8(18), Hex bolt, M8 x 10L(14), Open wrench— 13mm

STEP 7

Assemble the front post cover.

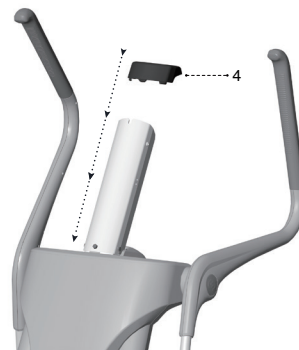

STEP 6

Assemble the front post.

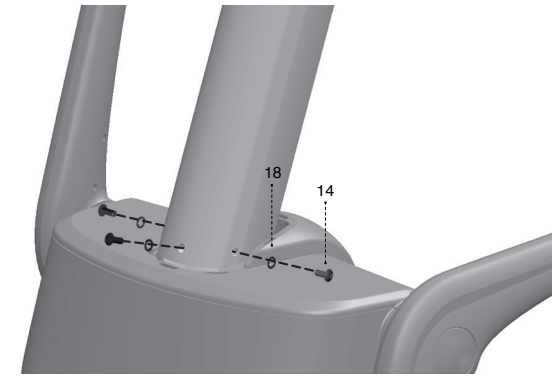

PLEASE NOTE

Tighten the front screw first. Make sure all 3 screws are tightened.

COMPONENTS AND TOOLS

Star washer, Black, M8(18), Hex bolt, M8 x 10L(14),

Open wrench— 13mm

STEP 8—1—1

Installing the 550ETXe2 console— Assemble the console.

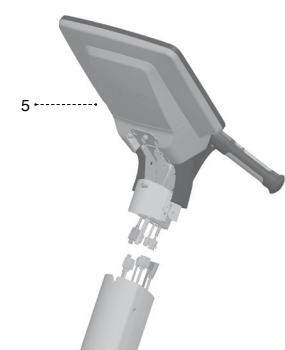
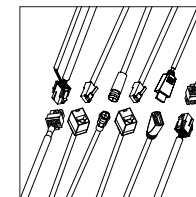

PLEASE NOTE

Connect the console cable, TV coax cable, TV power, RJ45 cable and HDMI cable, and carefully insert the cable into the front post.

2.4 550ETXe2 & 550ETXi Assembly Instructions

STEP 8-1-2

Installing the 550ETXe2 console— Assemble the console.

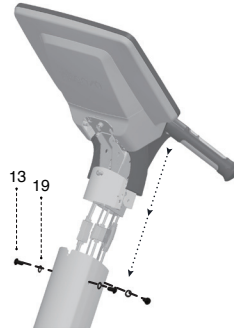

COMPONENTS AND TOOLS

Dome screw, M8 x 15L(13), Star washer, White, M8(19)

PLEASE NOTE

Make sure the post is properly aligned. Install and tighten the front screw first, then tighten the remaining 2 screws.

This screw is pre-assembled on the machine but not locked tight.

Please ensure it is locked tightly during installation.

STEP 8-1-3

Installing the 550ETXe2 console— Console Cover.

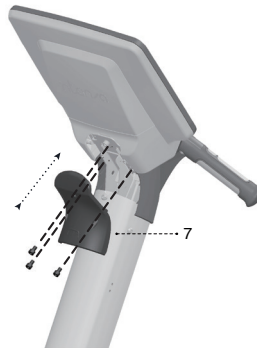

PLEASE NOTE

Install 3 screws and tighten.

COMPONENTS AND TOOLS

Tapping screw, M4 x 15L (16), Hex wrench— 3mm

STEP 8-2-1

Installing the 550ETXi console— Assemble the console.

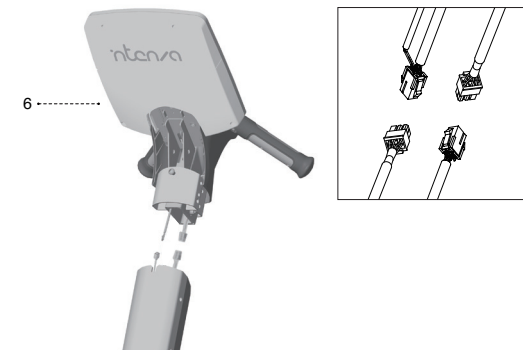

PLEASE NOTE

Connect the console cable, cable and carefully insert the cable into the front post.

2.4 550ETXe2 & 550ETXi Assembly Instructions

STEP 8-2-2

Installing the 550ETXi console— Assemble the console.

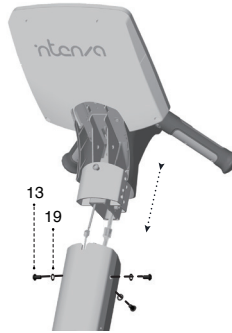

COMPONENTS AND TOOLS

Dome screw, M8 x 15L(13), Star washer, White, M8(19)

PLEASE NOTE

Make sure the post is properly aligned. Install and tighten the front screw first, then tighten the remaining 2 screws.

This screw is pre-assembled on the machine but not locked tight.

Please ensure it is locked tightly during installation.

STEP 8-2-3

Installing the 550ETXi console— Console Cover.



PLEASE NOTE

Install 3 screws and tighten.

COMPONENTS AND TOOLS

Tapping screw, M4 x 15L (16), Hex wrench— 3mm

STEP 8-2-4

Install the iPad rack.

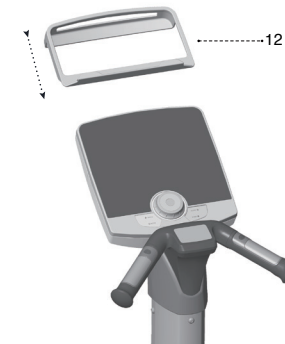

2.4 550ETXe2 & 550ETXi Assembly Instructions

STEP 9

Assemble the cup holder brackets.

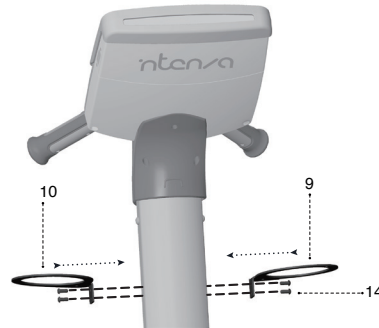

PLEASE NOTE

Identify the Right and Left bracket as shown above.

Attach the brackets using 4 dome screws as shown.

COMPONENTS AND TOOLS

Dome screw, M6 x 15L(15), Hex wrench— 5mm

STEP 11

Connect the adaptor.

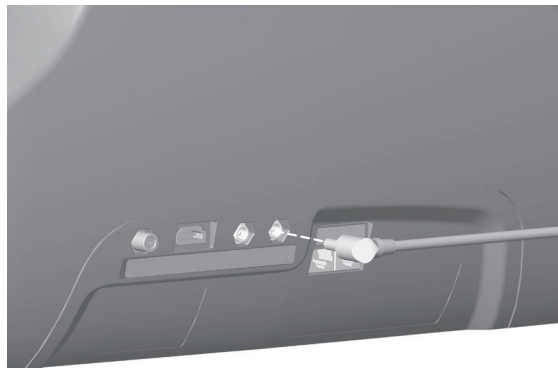

COMPONENTS AND TOOLS

Please use 12V 80W adaptor and insert adaptor's DC plug into DC power jack on the Elliptical cardio equipment.

STEP 10

Assemble the cup holders.



PLEASE NOTE

Install the cup holders and secure with 4 dome screws as shown.

COMPONENTS AND TOOLS

Dome screw, M6 x 15L(15), Hex wrench— 5mm

2.5 Safety Space

Make sure that the proper safety space, as shown below, around the equipment is maintained.

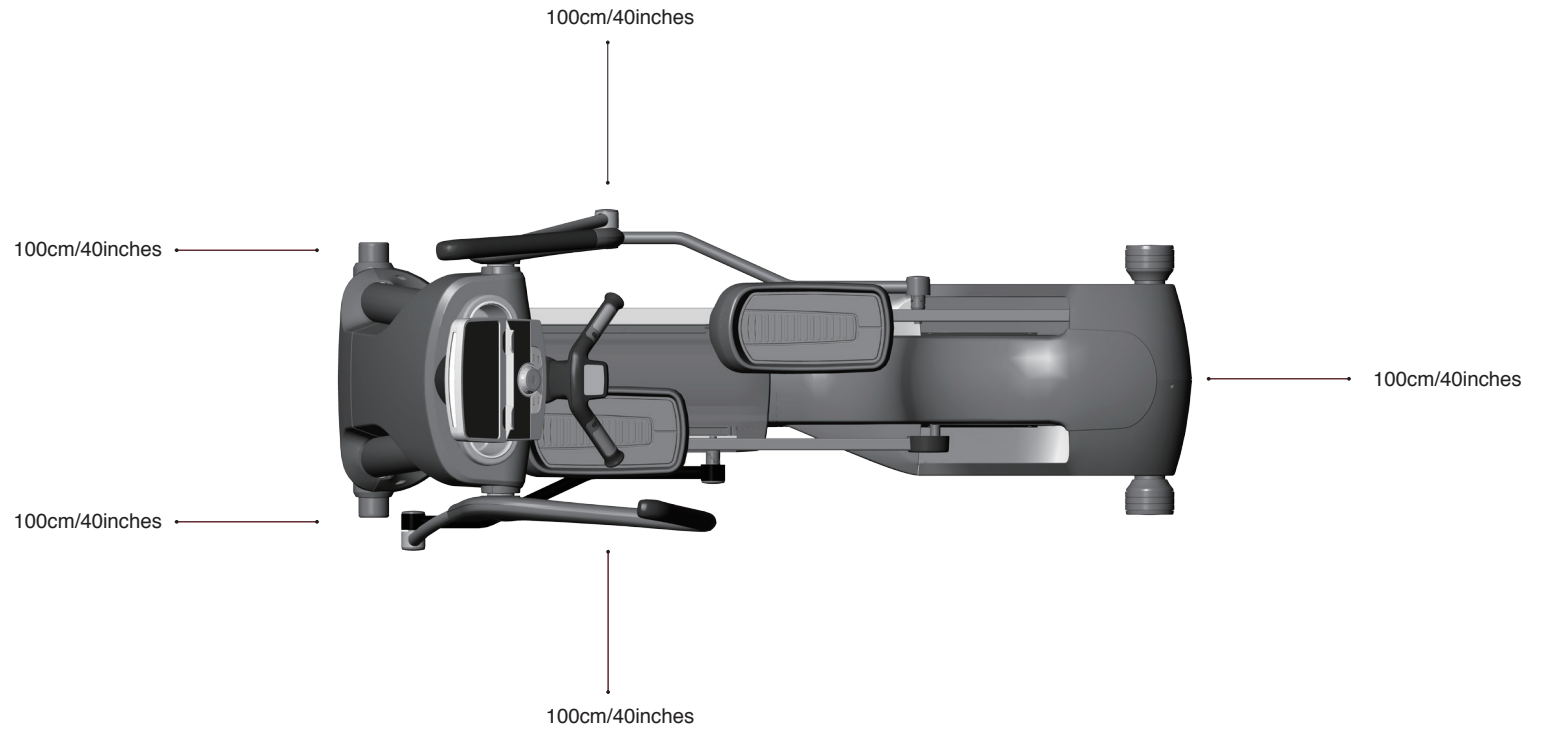









3. How To Use Intenza 550 Series Elliptical

Operating The Intenza 550 Series Elliptical is very easy.

Learning the features and incorporating the Intenza 550 Series Elliptical into your member's fitness program is just as easy.

In this chapter, you will learn the display function and how to get the most from workouts using the Intenza 550 Series Elliptical.

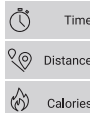
3.1 550ETXe2 Entertainment Console Overview

Language	Arabic, Dutch, English (UK English), English (US English), Finnish, French, German, Hungarian, Japanese, Korean, Persian, Polish, Portuguese, Russian, Spanish, Simplified Chinese, Traditional Chinese, Turkish, Lithuanian, Italian 20 languages are offered.
 Language	
Login	“Press” to login
 Login	
USB	Displays USB connection status.
	
Swipe	Swipe screen horizontally to jump to next available screen.
	
Homepage Picture	Homepage picture changes depending on the machine.
	
Quick Start	Allows users to start a workout immediately, by bypassing any setup or goal setting.
	
Favorite Programs	Allows the user easy access to frequently used programs.
	
Exercises	Please refer to section 5 workout options for additional information.
 Exercise	
Entertainment	TV/Intenzacast/ Internet/Video/Audio/Virtual scenery/YouTube/HDMI.
	During your workout, you can switch between different types of entertainment on the console.



- A ENERGY SAVER**
The energy saver mode is used to minimize the power consumption when the Intenza 550ETXe2 is not in use. Press this button to put the Intenza 550ETXe2 into energy saver mode after ending a workout. Press this button to “wake up” the Intenza 550ETXe2.
- B READING AND TABLET RACK**
Hold printed reading material, as well as mobile devices and tablets using this built—in rack.
- C OPTIONAL RFID/NFC**
Fitness facility owners can order this option for their users, allowing them to swipe facility identification card on the console.
- D HEADPHONE JACK**
Allows you to plug in headphones.
- E USB PORT**
Allows for data download. Read and play audio/video files.
- F HOME SCREEN**
See home screen table to the left.





3.2 550ETXe2 Entertainment And Media Operation

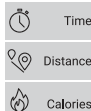

Users can select and set up entertainment items before entering a workout or quick start.

- TV: Watch live TV.
- Intenzacast: A wireless display standard designed for mirroring smart mobile devices to 550 e2 console.
- Internet: Users can quickly access pre-programmed websites and browse websites freely.
- Video/Audio: Watch or listen to a variety of videos or music audios (visible if USB device is detected).
- Reserved: Reserved function key (currently unassigned).
- Virtual scenery: A first-person, forward-motion video experience designed to enhance your workout.
- Youtube: Users can browse and enjoy YouTube videos while working out.
- HDMI Input: Allows users to connect any digital audio and video source, such as a DVD player or set-top box (visible if HDMI device is detected).

3.2.1 550ETXe2 Entertainment And Media Operation: TV

Screen Size Toggle		During a workout session, press to toggle between standard and full screen sizes.
Exercise Program		Exercise programs are listed on the left column for quick access.
Channel Keypad	0 1	Users can input the TV channels with the screen keypad displayed.
Workout Status		Press to show your workout statistics or progress.
Channel List		List of all available channels.
Volume		Tap volume in the display and slide the volume bar up/down to increase/decrease volume intensity. Enabled if headphones are detected.
Cool Down	COOL DOWN	Press during workout to begin a cool down period.
Stop	STOP	Press to stop the workout, then display workout summary and exit the workout program.
Pause	PAUSE	Press this key to pause the workout.
Back		Go back to Entertainment home screen.



Users can set up and watch TV before entering a workout—
Select TV on the Entertainment screen.

3.2.2 550ETXe2 Entertainment And Media Operation: Intenzacast





Intenzacast is a wireless technology that can be used to project your mobile device screen to 550ETXe2 consoles.

Users can personalize their workout experience by connecting their smart mobile devices (Apple or Android) to Intenzacast via RJ45 cable*.

* For best connectivity results we recommend connecting the 550ETXe2 console with RJ45 cables.

3.2.2 550ETXe2 Entertainment And Media Operation: Intenzacast

Intenzacast Steps

Workout Status		Press to show your workout statistics or progress.
Volume		Tap volume in the display and slide the volume bar up/down to increase/decrease volume intensity. Enabled if headphones are detected.
Quick Start	START	Allows the user to start a workout immediately, bypassing any setup or goal setting.
Back		Go back to Entertainment home screen.

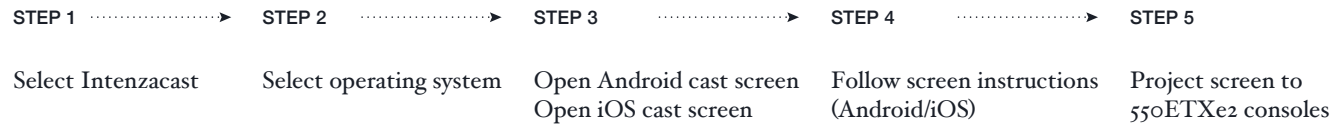

Detailed instructions for Intenzacast connection

It is recommended to set up Intenzacast from the Start Up or Main Screen before you start your work out.







1. If in a program, enter **entertainment** and select Intenzacast.
2. Select operating system (Android/iOS).
 - 3.1 Open Android cast screen
 - Swipe down with 2 fingers to skip notifications and head straight into the full quick settings panel, or double swipe down.
 - Choose Mirrocast on your smart phone.

PLEASE NOTE

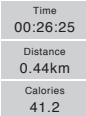
There are different names in different devices for Mirrocast, ie. Screen mirroring, Cast screen, HTC connect etc.

- 3.2 Open iOS cast screen:
 - Your device will automatically search for available networks.
 - Tap on the name **Intenza** to join. Please follow the instructions on e2 console display.
 - Swipe up from the bottom of your **iOS** device screen to access Control Center.
 - Tap AirPlay on your **iOS** device .
 - Tap the name of Intenzacast and then turn on Mirroring.
4. Follow cast screen instructions to connect Intenzacast.
5. Project screen to 550ETXe2 consoles.

3.2.3 550ETXe2 Entertainment And Media Operation: Internet

Screen Size Toggle		During a workout session, press to toggle between standard and full screen sizes.
Workout status		Display your workout status synchronously during browsing websites.
Workout Status		Press to show your workout statistics or progress.
Favorite Web List		List of saved websites (set up in Engineering mode only).
Volume		Tap volume in the display and slide the volume bar up/down to increase/decrease volume intensity. Enabled if headphones are detected.
Cool Down	COOL DOWN	Press during workout to begin a cool down period.
Stop	STOP	Press to stop the workout, then display workout summary and exit the workout program.
Pause	PAUSE	Press this key to pause the workout.
Back		Go back to Entertainment home screen.
Keyboard		Users can input a website address with the screen keypad displayed.



Internet browsing at your fingertips—550ETXe2 consoles.

Users can personalize their workout experience by connecting their smart mobile devices (Apple or Android) to Intenzacast*.

*For internet access we highly recommend connecting 550ETXe2 consoles with ETHERNET cables to protect Intenzacast operating stability.

3.2.4 550ETXe2 Entertainment And Media Operation: Audio/Video

Screen Size Toggle  During a workout session, press to toggle between standard and full screen sizes.

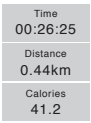
Workout Status  Display your workout status while browsing websites.

Previous/Next  In “now playing” press Previous/Next to skip to the previous/next song or video in the list.

Workout Status  Press to show your workout statistics or progress.

Play List  Sort USB music, songs or video content by playlist.

Volume  Tap volume in the display and slide the volume bar up/down to increase/decrease volume intensity. Enabled if headphones are detected.

Cool Down  Press during workout to begin a cool down period.

Stop  Press to stop the workout, then display workout summary and exit the workout program.





Pause  Press this key to pause the workout.

Back  Go back to Entertainment home screen or workout status dashboard.

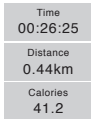

Inserting a pre—loaded audio/video programmed USB—

3.2.5 550ETXe2 Entertainment And Media Operation: Virtual Scenery





Screen Size Toggle		During a workout session, press to toggle between standard and full screen sizes.
Workout Status		Display your workout status while browsing websites.
Swipe		Swipe screen horizontally to jump to next available screen.
Workout Status		Press to show your workout statistics or progress.
Virtual Scenery List		List of all virtual scenery videos. Users can choose from available videos.
Cool Down	COOL DOWN	Press during workout to begin a cool down period.
Stop	STOP	Press to stop the workout, then display workout summary and exit the workout program.
Pause	PAUSE	Press this key to pause the workout.
Back		Go back to Entertainment home screen or workout status dashboard.

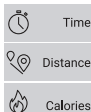

Virtual scenery is a first—person, forward—motion video experience designed to enhance users workouts.

Scenery using beautiful locations has been created to turn indoor exercise spaces into outdoor adventures. Virtual scenery interacts with the equipment to provide an immersive experience. The frame rate of the video is increased, or decreased, based on the speed of the connected exercise equipment.

3.2.6 550ETXe2 Entertainment And Media Operation: YouTube* **

Screen Size Toggle		During a workout session, press to toggle between standard and full screen sizes.
Exercise Program		Pressing the left side button list allows users quick access to exercise programs.
Workout Status		Press to show your workout statistics or progress.
Volume		Tap volume in the display and slide the volume bar up/down to increase/decrease volume intensity. Enabled if headphones are detected.
Cool Down	COOL DOWN	Press during workout to begin a cool down period.
Stop	STOP	Press to stop the workout, then display workout summary and exit the workout program.
Pause	PAUSE	Press this key to pause the workout.
Back		Go back to Entertainment home screen.



Users can browse and enjoy YouTube videos while working out—

*Similar operation for Youku (China).

**Similar operation for Aparat (Iran).

3.2.7 550ETXe2 Entertainment And Media Operation: HDMI Input _____

PLEASE NOTE Features of HDMI input are only applicable on consoles shipped with an integrated HDMI device.

HDMI technology is the global standard for connecting high—definition equipment.

HDMI input is an alternative way to provide TV programs that use a HDMI single connect cable and signals as opposed to traditional coaxial cable and RF signals. It allows you to connect any digital audio and video source, such as a DVD player or set—top box to 550ETXe2 console.

3.3 550ETXi Interactive Console Overview

A Profile Window
This window displays the exercise profile for the selected workout.

B Message Bar
During the program set-up, operating instructions will be displayed in the message bar. During the workout, exercise data will be displayed below for your reference.

HR heart rate can be detected if the user is wearing the Polar heart rate chest strap or by holding onto the contact heart rate grips consistently.

LEVEL intensity of resistance level.

TIME the time elapsed since beginning the workout.

SPM (Stride Per Minute) the number of strides at which you are currently pedaling in stride per minute.

CALORIES the number of calories burned since beginning the workout.

WATTS effort level in Watts. Watt is a unit of power output or the expression of the mechanical rate of work.

DISTANCE the total number of miles or



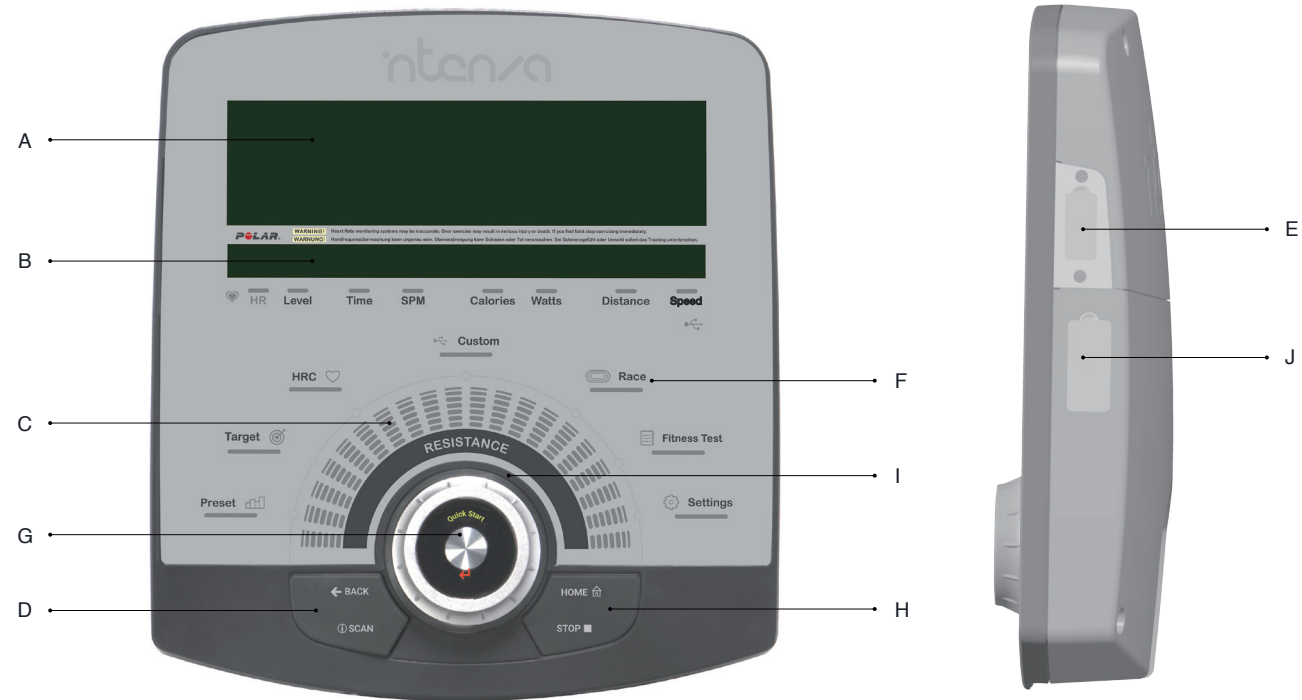



C Resistance Scale
Increase/decrease the resistance level from 1 (least difficult) to 40 (most difficult) by adjusting the Uni-Dial™ Navigation control clockwise for increased resistance, or counter clockwise for decreased resistance. Users can customize the resistance of their workouts.



Your Intenza 550ETXi is equipped to provide you and your users unlimited exercise opportunities.

Experiment with each feature to find the right combination for your fitness regimen. The console provides the operating controls and display elements described in the following paragraphs.

3.3 550ETXi Interactive Console Overview

- D** Back/ iSCAN
During program set up, press this key to go back to previous selection for correction.
-  **BACK** During the name setting, press this key to correct wrong input.
During the workout, the display information toggles between both exercise parameters in each message bar. Press **SCAN** to display one of the parameters statistic continuously throughout the workout.
-  **SCAN**
-
- E** USB Icon
This icon lights up when the Intenza console detects a USB device.
-
- F** Programs
Please refer to Section 5 Exercise Workout Option.
-
- G** Quick Start/Enter
Press this key to enter the manual workout mode promptly, without selecting a workout program. The resistance level is 8.
-  **Quick Start**
-  **ENTER** During program set up, press this key to confirm selection or value.
-
- H** Home/Stop Key
Press this key to go back to the starting screen when necessary. During the setting of saving confirmation, press this key to double confirm. (Please refer to Section 4 Exercise Workout Option.)
-  **HOME**
-  **STOP** This key is only effective when a selected program is in operation. Pressing **STOP** once will end the workout program and the message bar will show the workout summary. Pressing **STOP** again will exit the workout program promptly.
- I** InZone™
The Uni—Dial™ skirting light indicates the workout intensity.
-
- J** C—SAFE port
All commercial Bikes, Treadmills, Escalate and Elliptical Trainers built after October 2014 are C—SAFE compatible.

PLEASE NOTE The Intenza 550 Series Elliptical's heart rate function is intended for use only as an exercise aide. Various factors can affect the accuracy of your heart rate reading. The heart rate function of the Intenza 550 Series Elliptical should not be considered, or used, as a medical device.

3.4 How To Effectively Workout At Your Own Level

InZone™ system provides visual color feedback by illuminating the Uni—Dial's™ skirting light.

The different colors encourage users to optimize their workout efforts for maximum results based on heart rate level, and helps users to stay in their target heart rate zones. The InZone™ system detects heart rate by i) holding onto the contact heart rate plates or ii) by wearing a telemetry heart rate chest strap sensor. It is recommended that users wear a telemetry heart rate chest strap for this function. During a workout there are 4 different colors that represent a workout intensity.

GREEN: THE ENERGY EFFICIENT OR RECOVERY ZONE: 55% TO 65%

Training within this zone develops basic endurance and aerobic capacity. All low intensity peddling should be completed at a maximum of 65%.

YELLOW: THE AEROBIC ZONE: 65% TO 75%

Training in this zone may improve your cardiovascular system. The body's ability to transport oxygen and carbon dioxide to, and away, from the working muscles may developed and improved.

ORANGE: THE ANAEROBIC ZONE: 75% TO 85%

Training in this zone may develop your lactic acid system. In this zone, your individual anaerobic threshold (AT), sometimes referred to as the point of deflection (POD), is found. In the heart rate zone, the amount of fat being utilized as the main source of energy is greatly reduced and glycogen stored in the muscle is predominantly used. One of the by—products of burning glycogen is lactic acid. The point at which the body can no longer quickly remove the lactic acid from the working muscles is your anaerobic threshold (AT). Through the correct training, it is possible to delay the AT by being able to increase your ability to deal with the lactic acid for a longer period of time or by improving your AT level.

RED: THE EXTREME ZONE: 85% TO 100%

The Red is a high intensity work out. It effectively trains your fast—twitch (type II) muscle fibers and helps to develop speed. This zone is reserved for interval cycling.

3.5 How To Personalize Your Workout

PLEASE NOTE The USB Screen Jump Button only appears if a USB device is plugged in and detected. When you remove the USB stick from the port, replace the USB port cover.

Users can personalize the workout routine via USB.

This port can also be used by trained service technicians for troubleshooting purposes.

Workout Data: While you exercise, your Intenza 550 Series Elliptical console will keep track of the following exercise parameters—

HR	LEVEL	TIME	CALORIES
WATTS	DISTANCE	SPEED	

These values will be recorded once every five seconds during the workout, if you have a installed a USB device before you began a workout program. Your downloaded data will be placed in a ELLIPT folder on your USB device as a .csv (Microsoft Excel compatible) format. You can open this file on your computer to view and track your workout progress. The USB port is on the right side of the console. When a USB is plugged into this port, the USB icon will light up.

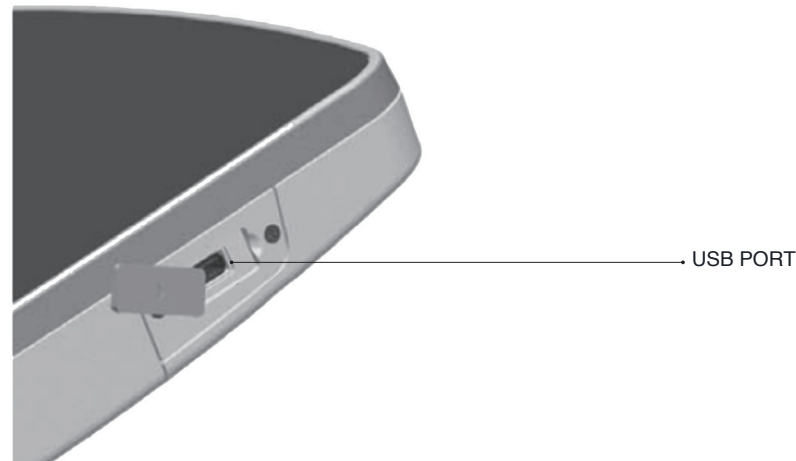

3.6 Save The Workout Profile.

3.6.1 Save The Workout Profile: 550ETXe2

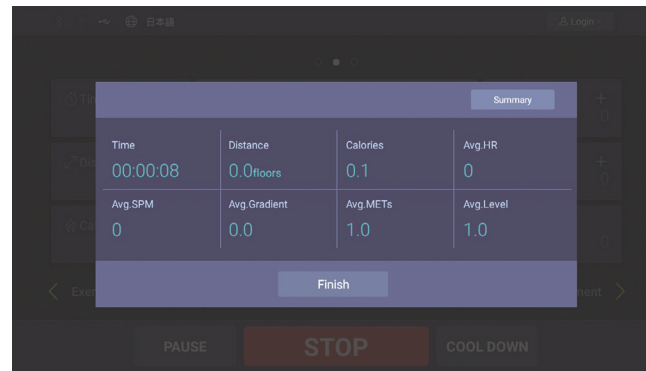

Insert the USB device to USB port, if you want to save the workout profile—

STEP 1>

Press **STOP** to enter the workout summary mode and save the workout profile.

STEP 2>

Choose **SAVE** to confirm saving.

STEP 3

Choose **FILE (SUNDAY—SATURDAY)** and press **YES** to confirm. When the display shows **SUCCESS** saving process is complete.

3.6.2 Save The Workout Profile: 550ETXi

Insert the USB device to USB port, if you want to save the workout profile—

STEP 1>

Press **STOP** or **ENTER** again to exit the workout summary mode and save the workout profile.

STEP 2>

Choose **YES** to confirm saving or **NO** to exit by turning the Uni—Dial™ and press **ENTER** to double confirm.

STEP 3

Choose **FILE (SUNDAY—SATURDAY)** by turning the Uni—Dial™ and press **ENTER** to confirm. When the display shows **SAVING COMPLETE** saving process is complete.

3.7 How To Track Your Workout Record

You can easily personalize the workout routine and the workout data to manage your workout record.

To easily track the record, there are three folders— Custom, Fitness and Workout data. Each folder contains the record of the workout program.

3.7.1 Custom

This folder contains 7 files of the workout profile users saved as DAYS.

- CUSTOM_SUN
- CUSTOM_MON
- CUSTOM_TUE
- CUSTOM_WED
- CUSTOM_THU
- CUSTOM_FRI
- CUSTOM_SAT

Route: ELLIPT\CUSTOM

Data	80	108	108	30	30	60
Data2	0	0	0	0	0	0
Time	20	20	20	20	20	20
Profile Type	0	0	0	3	3	3

Data = Level of workout interval
80 = Lv8
40 = Lv4

Data2 = N/A

Time(s) = seconds of workout interval
20 = 20 seconds

ProfileType:
1 = Level Profile
3 = Watt Profile
0 = HR Profile

Route: ELLIPT\CUSTOM\CUSTOM_SUN

3.7.2 Fitness

This folder contains files of Fitness Test score records.

The value is the score users attained by fitness test.

Information of Astrand—Rhythmic workout records

- The file will save up to 30 score records, the most current record will be at the bottom.
- The score recorded onto the USB needs to be multiplied by 0.1 to match the score displayed on the console. Please refer to example below and Section 5.7 VO₂ MAX chart for more information.

Score Array List	963	504
-------------------------	-----	-----

Route: ELLIPT\FITNESS\FITNESS_SCORE

.....> **Score Array List:**
963 = 96.3 = 1st VO₂ max score
504 = 50.4 = 2nd VO₂ max score
and etc.

3.7.3 Workout Data







This folder contains workout data files from all Intenza 550 Series Elliptical programs.

The workout record will be saved automatically every 5 seconds.

Information meaning • Time: unit is 5 seconds.

- Calories: the accumulated calories burned during the workout.
- Distance: the accumulated running distance during the workout.

Score record in USB file needs to be multiplied by a certain value in order to match the score displayed in the console. MET and Speed data should be multiplied by 0.1. Distance data should be multiplied by 0.01. Please refer to example below. Route: ELLIPT\WKODATA\20170503_133606.CSV

-  20170503_133606
-  20170503_133722
-  20170504_122635
-  20170504_141330
-  20170505_091533
-  20170506_100624

Route: ELLIPT\WKO_DATA

	LEVEL	SPM	WATTS	SPEED	HR	TIME	CALORIES	DISTANCE
1	1	49	19	104	0	3	0	0
2	1	50	19	107	0	8	0	2
3	8	51	41	109	0	13	0	3
4	8	52	41	111	0	18	1	5

Level =
Workout intensity

SPM =
Strides per minute which is default unit for cadence in most of sport.

Watts =
The unit of power per second

SPEED data x 0.1
13 x 0.1 = 1.3 (kph/mph)

DISTANCE data x 0.01 = DISTANCE
1 X 0.01 (kph/mile)

Route: ELLIPT\WKO_DATA\

3.8 Setting of Intenza 550 Series Elliptical

PLEASE NOTE The USB Screen Jump Button only appears if a USB device is plugged in and detected.

Users can customize their personal settings through USB.

This friendly and convenient function is compatible with both series of Intenza products, e-series and i-series. You can enjoy your workout and enter the programs promptly without having to re-enter personal information (name, age, weight) setting. After using the Intenza 550ETXe2 for a period of time, you may want to change some of the basic settings, eg. distance unit or sound.

3.8.1 Intenza 550ETXe2

Personalize and change the settings with USB device

STEP 1▶

Insert USB device to USB port.

STEP 2▶

Press the  Login on the screen.

STEP 3

Follow the onscreen instructions.

3.8.2 Intenza 550ETXi

PLEASE NOTE The 550 series interactive console only supports USB in FAT format. If your USB is in NTFS format, you will need to reformat your USB to FAT format in order for it to be used in Intenza consoles.

Personalize the setting with a USB device—

STEP 1

Insert USB device to USB port.

STEP 2

Select **UNIT** (Km/Mile) by turning Uni—Dial™ and press **ENTER**.

STEP 3

Input **AGE** by turning Uni—Dial™ and press **ENTER**.

STEP 4

Input **WEIGHT** by turning Uni—Dial™ and press **ENTER**.

STEP 5

Select the **SOUND** (On/Off) by turning Uni—Dial™ and press **ENTER**.

STEP 6

Input **NAME** using alphabet by turning Uni—Dial™ then press **ENTER** to confirm selected letter. Then select **END** to confirm **NAME** editing.

STEP 7

During name editing, you can press **BACK** to edit and correct input.

STEP 8

When you pause for 5 seconds or press **STOP**, **END** will appear. You can press **ENTER** to confirm and exit setting mode.

Change the 550ETXi setting—

STEP 1 →

Choose **SETTING** by turning Uni—Dial™ and press **ENTER**.

STEP 2 →

Select **UNIT** (Km/Mile) by turning Uni—Dial™ and press **ENTER**.

STEP 3 →

Select **SOUND** (On/Off) by turning Uni—Dial™ and press **ENTER**.

STEP 4

Lastly, you will see the display version, press **ENTER** to return to home page.

3.9 Begin The Workout

Before beginning any fitness program, see your physician for a complete physical examination.

To maintain your balance, always grasp the handlebar when you step on, or off, the foot pedals, or use the keypads.

1. Hold on to the handlebar and step on the foot pedals.
2. When you are in a stable position, begin to pedal.



The handlebars on the Elliptical Trainer provide an upper—body workout which helps increase cardiovascular fitness. In addition to pedal forward, a program of reverse training focuses on the entire lower body by pedaling backwards. Various workout postures keep your workout fresh and exciting in any program.



PLEASE NOTE To enter into this workout on the Intenza 550ETXe2, follow the onscreen prompt message.

4. Workout Options

This section outlines Intenza 550 Series Elliptical pre-programmed workouts.

The workout programs are easily accessed by turning the Uni-Dial™ dial and pressing ENTER to start the programs. By inserting a USB device before starting your workout, the Intenza console system will save your workout record automatically to the USB device every five seconds during your workout.

4.1 Quick Start

Quick Start allows users to begin a workout with one key press.

You can also pedal for 10 seconds with a minimum 40 SPM for automatic quick start. Quick Start defaults are at LEVEL 8 resistance. Resistance levels can be adjusted during the workout. The workout record is saved automatically every 5 seconds, when your personal USB device is installed prior to beginning your workout. When you complete the workout, your profile is saved to the USB device as a routine workout by filename of days to track your exercise progress.

To operate Quick Start program

STEP 1

Step on the Elliptical Trainer, begin to pedal.

STEP 2

Pedal with a minimum 40 SPM or press **QUICK START** to enter the workout.

STEP 3

You can adjust the resistance level during the program by touching the console screen (550ETXe2) or turning the Uni-Dial™ (550ETXi).

STEP 4

During the workout, InZone™ will indicate your change in heart rate.

STEP 5

During the workout, the workout data will be shown in the message bar under scan mode. Press **SCAN** to lock the workout data.

STEP 6

If you wish to **PAUSE** the workout

- For 550 ETXe2, press **PAUSE**.
- For 550TXi, press **STOP**.

In pause mode, the countdown timer will appear for 3 minutes and then the power will go off. You can press **START** and run to restart the console.

STEP 7

For 550 ETXe2, if you wish to cool down the workout, press **COOL DOWN**. The time will automatically count down from 4 minutes. You can adjust the cool down time by touching ▲▼ to extend or shorten time.

STEP 8

Press **STOP** key or touch **STOP** on screen, if you wish to exit the program before reaching your workout goal, press **STOP** again or allow pause or cool down timer to expire.

STEP 9

Save the workout profile. (Please refer to Section 3.6 Save The Workout Profile).

4.2 Preset Program

The Intenza 550 Series Elliptical is designed with many preset programs to add variety and challenges to your workout plan.

Each program provides different benefits and can help you to achieve your own personal fitness goals.

4.2.1 Preset Program: Intenza 550ETXe2



Workout procedure



4.2.1 Preset Program: Intenza 550ETXe2

Workout procedure

STEP 1	STEP 2	STEP 3	START
MAIN PROGRAM 1:3 interval 1:2 interval 1:1 interval 3 step interval Easy Hills Rolling Hills Peak Hills Step HIIT Beginner HIIT Advanced	WORKOUT TIME Time setting: 10—99 Minutes	MAX. LEVEL Level setting: 8—40 levels (Resistance only)	

Detailed instructions for Intenza 550ETXe2

STEP 1

Step on the Elliptical Trainer, begin to pedal.

STEP 2

If you want to save your workout record, insert USB device to the USB port.

STEP 3

Choose **PRESET** by touching console screen.

STEP 4

Choose **PROGRAM** by touching console screen.

STEP 5

Input your age, gender, weight.

STEP 6

Input the desired **WORKOUT TIME** by touching console screen.

STEP 7

Input **MAX LEVEL** by touching console screen.

STEP 8

During the reverse training workout, follow the message to pedal forwards/backwards.

STEP 9

The timer will appear and count down for 3 seconds, then you will enter **WARM UP** timer, you can adjust the warm up time between 1—99 minutes, or touch **SKIP** to enter the workout.

STEP 10

If you wish to **PAUSE** the program, stop pedaling. In pause mode, the countdown timer will appear for 1 minute, the power will go off after 1 minute. You can pedal to restart the console within 1 minute.

STEP 11

Press **STOP** key, if you wish to exit the program before reaching your workout goal, stop pedaling or allow pause timer to expire.

STEP 12

Save the workout profile.

PLEASE NOTE MAX SPM is the peak of each column of workout profile. You need to input the **MAX SPM** for your own workout target according to your physical ability. You may also adjust resistance levels during the workout.

To enter into this workout on 550ETXe2, follow the onscreen prompt message.

4.2.2 Preset Program: Intenza 550ETXi

Detailed instructions for Intenza 550ETXi—

STEP 1

Step on the Elliptical Trainer, begin to pedal.

STEP 2

If you want to save your workout record, insert USB device to the USB port.

STEP 3

Choose **PRESET** by turning Uni—Dial™ and press **ENTER** to confirm.

STEP 4

Choose **PROGRAM** by turning Uni—Dial™ and press **ENTER** to confirm.

STEP 5

Input your age, gender, weight.

STEP 6

Input the desired **WORKOUT TIME** by turning Uni—Dial™ and press **ENTER** to confirm. The console displays a default time of 30 minutes. You may enter anytime between 10 to 99 minutes

STEP 7

Input **MAX LEVEL** by turning Uni—Dial™ and press **ENTER** to confirm.

STEP 8

During the reverse training workout, follow the message to pedal forwards/backwards.

STEP 9

During the workout InZone™ Heart Rate Training will indicate heart rate zone.

STEP 10

During the workout, the workout data will be shown in message bar under scan mode. Press **SCAN** to lock the workout data.

STEP 11

If you wish to **PAUSE** the program, stop pedaling. In pause mode, the countdown timer will appear for 1 minute, the power will go off after 1 minute. You can pedal to restart the console within 1 minute.

STEP 12

Press **STOP** key, if you wish to exit the program before reaching your workout goal, stop pedaling or allow pause timer to expire.

STEP 13

Save the workout profile.

PLEASE NOTE Before starting a workout, 550ETXe2 users can set speed levels (1—25 km/h, 0.5—16 mph).

4.3 Target Program

The Intenza 550 Series Elliptical offers 3 target workout options to meet your training goals.

By setting time, distance, or calories, you may choose the program by touching the console screen or turning the Uni—Dial™ to enter the program. If you want to save the workout record, insert a USB device before beginning your workout.

4.3.1 Target Program: Intenza 550ETXe2

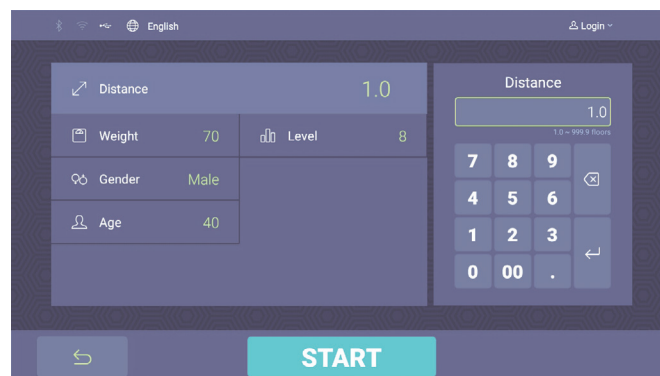

Workout procedure

STEP 1	STEP 2	START
PROGRAM	TARGET	
Distance	Distance Setting: 1—60 mi /1—99 km	
Time	Time Setting: 10—99 minutes	
Calories	Calorie Setting: 10—9,999 kcal	

4.3.1 Target Program: Intenza 550ETXe2

Detailed instructions for Intenza 550ETXe2

STEP 1

Step on Intenza 550ETXe2 running platform.

STEP 2

To save your workout record, insert a USB device to the USB port.

STEP 3

Choose **TARGET** program by touching the console screen.

STEP 4

Choose **PROGRAM** (Distance, Time, Calories) by touching the console screen.

STEP 5

Input your age, gender, weight.

STEP 6

Input the target value by touching the console screen. The distance range is from 1–60 mi/1–99 km, the time range is from 10–99 minutes, and the calories range is from 10–2,500 kcal.

STEP 7

The timer will appear and count down for 3 seconds, then you will enter **WARM UP** timer, you can adjust the warm up time between 1–99 minutes, or touch **SKIP** to enter the workout.

STEP 8

If you wish to **PAUSE** the program, press **STOP** or touch **PAUSE** on console screen. In pause mode, the timer will appear and countdown for 3 minutes, you can adjust the pause time by touching ▲ ▼ to extend or shorten the time. You can pedal to restart the console within 1 minute. If you wish to cool down the workout, press **COOL DOWN**. The time will automatically count down from 4 minutes. You can adjust the cool down time by touching ▲ ▼ to extend or shorten the time.

STEP 9

Press **STOP**, if you wish to exit the program before reaching your workout goal, or stop pedaling and allow pause timer to expire.

4.3.2 Target Program: Intenza 550ETXi

Workout procedure

STEP 1	STEP 2	START
PROGRAM	TARGET	
Distance	Distance Setting: 1—60 mi/1—99 km	
Time	Time Setting: 10—99 minutes	
Calories	Calorie Setting: 10—2,500 kcal	

Detailed instructions for Intenza 550ETXi

STEP 1

Step on the Elliptical Trainer, begin to pedal.

STEP 2

To save your workout record, insert a USB device to the USB port.

STEP 3

Choose **TARGET** program by turning the Uni—Dial™ and press **ENTER** to confirm.

STEP 4

Choose **PROGRAM (Distance, Time, Calories)** by turning the Uni—Dial™ and press **ENTER** to confirm.

STEP 5

Input your age, gender, weight.

STEP 6

Input the target value by turning the Uni—Dial™ and press **ENTER** to confirm. The distance range is from 1—60 mi/1—99 km, the time range is between 10—99 minutes, and the calories range is between 10—2,500 kcal. Press **ENTER** to confirm.

STEP 7

The timer will appear and count down for 3 seconds, then the workout will start automatically.

STEP 8

During workout the **INZONE™** will indicate your change of heart rate.

STEP 9

During workout, data will be shown in message bar under **SCAN** mode. Press **SCAN** to lock the workout data.

STEP 10

If you wish to **PAUSE** the program, stop pedaling. In pause mode, the timer will appear and countdown for 1 minute, the power will go off after 1 minute. You can pedal to restart the console within 1 minute.

STEP 11

Press **STOP**, if you wish to exit the program before reaching your workout goal, or stop pedaling and allow pause timer to expire.

4.4 HRC Program

The Intenza 550 Series Elliptical offers 4 heart rate control workout options.

The heart rate control workout program allows the user to program their target heart rate zone. During the HRC program, the screen's LED will show the profile below which represents the target heart rate zone. Each column represents 1 minute of workout. The column that the user is currently using will flash for reference. Input the target workout heart rate % and your age, and the Intelligent HR system will automatically calculate the personal target. The heart rate zone is calculated by using the following equation: $(220 - \text{Age}) \times \% = \text{heart rate target zone}$. The user must wear a telemetry heart rate chest strap for this workout.

HEART RATE ZONE

AGE	60%	65%	70%	75%	80%	85%
10	126	137	147	158	168	179
20	120	130	140	150	160	170
30	114	124	133	143	152	162
40	108	117	126	135	144	153
50	102	111	119	128	136	145
60	96	104	112	120	128	136
70	90	98	105	113	120	128
80	84	91	98	105	112	119
90	78	85	91	98	104	111
99	73	79	85	91	97	103

HEART RATE CONTROL PROGRAM OPTIONS

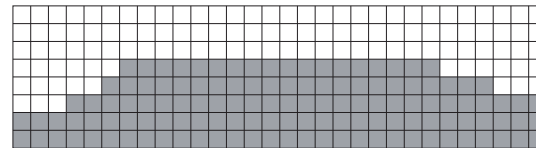

Constant HR

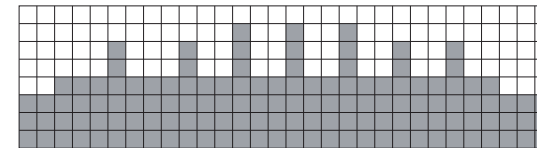

Interval HR

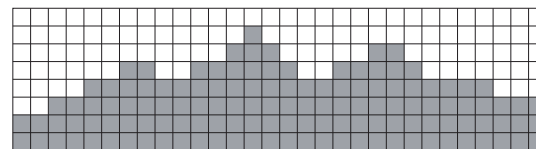

Hill HR

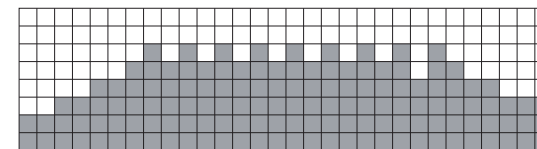

Cardio HR

4.4.1 Intenza 550ETXe2

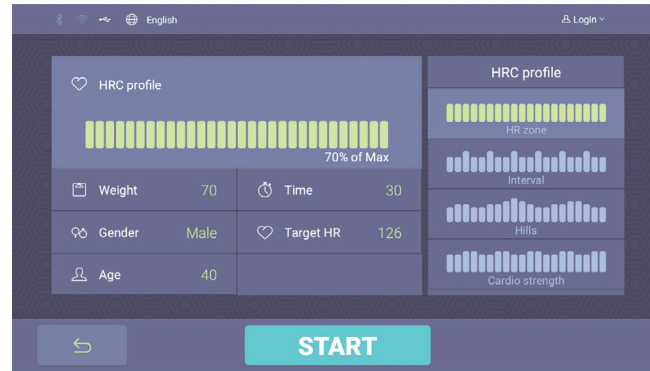

Workout procedure

STEP 1	→	STEP 2	→	STEP 3	→	STEP 4	→	START
PROFILES		WORKOUT TIME		AGE		TARGET HR		
HR Zone		Time Setting:		Age Setting:		Refer to Heart		
Interval HR		10—99 Minutes		10—99		Rate Zone Table		
Hill HR								
Cardio Strength								

4.4.1 Intenza 550ETXe2

Detailed instructions for Intenza 550ETXe2

STEP 1

Step on the Elliptical Trainer and begin pedaling.

STEP 2

To save your workout record, insert a USB device to the USB port.

STEP 3

Choose **HR Control** by touching the console screen.

STEP 4

Choose **MODE (HR ZONE/INTERVAL /HILLS /CARDIO STRENGTH)** by touching the console screen.

STEP 5

Input the **WORKOUT TIME** you want by touching console screen and press **↵** to confirm. You can choose between 10 to 99 minutes.

STEP 6

Input your **AGE** by touching console screen and press **↵**.

The default age value is 40 years of age. You can adjust the value between 10 to 99 years years of age.

STEP 7

Input **TARGET HEART RATE** by touching console screen and press **↵** to confirm.

STEP 8

The timer will appear and count down for 3 seconds, then you will enter **WARM UP** timer, you can adjust the warm up time between 1—99 minutes, or touch **SKIP** to enter the workout.

STEP 9

If you wish to **PAUSE** the program, press **STOP** or touch **PAUSE** on console screen. In pause mode, the timer will appear and count down for 3 minutes, or you can adjust the pause time by touching **▲▼** to extend or shorten the time. You can pedal to restart the console within 1 minute.

STEP 10

Press **STOP**, if you wish to exit the program before reaching your workout goal or stop pedaling and allow pause timer to expire.

PLEASE NOTE Calculating your theoretical maximum heart rate by using age is an approximation. For more information, please contact a fitness professional or physician.

You must wear a telemetric heart rate chest strap for HRC program. Contact HR cannot be detected at HRC.

The default **TARGET HR** (Percentage of max HR) of each mode of heart rate control program is set for different training purposes.

4.4.2 Intenza 550ETXi

Workout procedure

STEP 1	STEP 2	STEP 3	STEP 4	START
MODE	WORKOUT TIME	AGE	TARGET HR	
Constant HR				
Interval HR	Time Setting: 10—99 Minutes	Age Setting: 10—99	Refer to Heart Rate Zone Table	
Hill HR				
Cardio HR				

Detailed instructions for Intenza 550ETXi

STEP 1

Step on the Elliptical Trainer and begin pedaling.

STEP 2

To save your workout record, insert a USB device to the USB port.

STEP 3

Choose **HRC** by turning the Uni—Dial™ dial and press **ENTER** to confirm.

STEP 4

Choose **MODE** (**CONSTANT HR/INTERVAL HR/HILL HR/CARDIO HR**) by turning the Uni—Dial™ and press **ENTER** to confirm.

STEP 5

Input your **AGE** by turning the Uni—Dial™ and press **ENTER**.

STEP 6

Input the **WORKOUT TIME** you want by turning the Uni—Dial™ and press **ENTER** to confirm. You can choose time between 10 to 99 minutes.

STEP 7

Input your **AGE** by turning the Uni—Dial™ and press **ENTER**. The default age value is 30 years of age. You can adjust the value between 10 to 99 years of age.

STEP 8

Input **TARGET HEART RATE** by turning the Uni—Dial™ and press **ENTER** to confirm.

STEP 8

Choose **HRC** by **SPEED** by turning the Uni—Dial™ and press **ENTER** to confirm.

STEP 9

The timer will display and count down for 3 seconds then the workout will start automatically.

STEP 10

During the workout, data will be displayed in message bar under **SCAN** mode. Press **SCAN** to lock the workout data.

STEP 11

During workout **INZONE™** will indicate your change in heart rate.

STEP 12

If you wish to **PAUSE** the program, stop pedaling. In pause mode, the timer will appear and countdown for 3 minutes, the power will go off after 3 minutes. You can pedal to restart the console within 1 minute.

STEP 13

Press **STOP**, if you wish to exit the program before you reach your workout goal or stop pedaling and allow pause timer to expire.

4.5 Custom Program

The Custom program allows a user to save personal workout data onto a USB.

You can customize the workout profile to meet your own workout goal. By using CUSTOM program, you may easily track exercise progress and choose the program you desire from the folders.

4.5.1 Intenza 550ETXe2

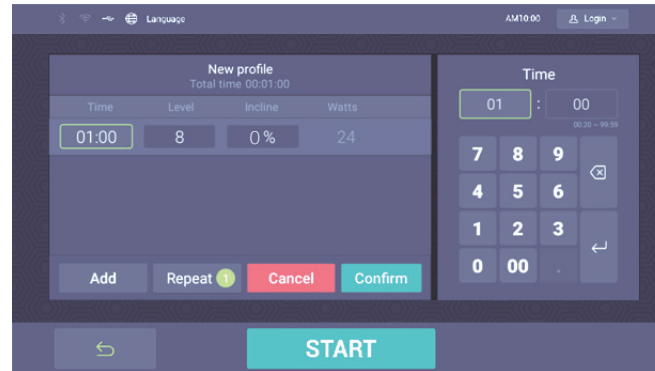

Detailed instructions for Intenza 550ETXe2

STEP 1

Step on the Elliptical Trainer and begin pedaling.

STEP 2

Insert a USB device to USB port otherwise custom program is unable to operate.

STEP 3

If you want to create new profile, please follow the procedure below

A	B	C	START
CREATE NEW PROFILE	TIME	OPTIONAL INPUT	
LEVEL	Time Setting 00:20—99:59	LEVEL 1—40	
HRC		Target HR setting 108—180	

STEP 4

You can choose **ADD** to create other new profiles.

STEP 5

You can choose **REPEAT** and + to create more than one identical profiles.

STEP 6

During the workout, you can adjust speed.

STEP 7

If you wish to **PAUSE** the program, press **STOP**. In pause mode, the timer will display and countdown for 1 minute, the power will go off after 1 minute. You can pedal to restart the console within 1 minute.

STEP 8

Press **STOP**, if you wish to exit the program before reaching your workout goal or stop pedaling and allow pause timer to expire.

STEP 9

If you want to keep the workout profile in the USB, choose **YES** to save the workout profile.

4.5.2 Intenza 550ETXi

The custom program offers max 7 personal profiles saved by default file name—

Monday, Tuesday, Wednesday, Thursday, Friday, Saturday and Sunday.

A>	B>	START
SAVE FILE	WORKOUT TIME	
Monday—Sunday	Time Setting 20—99 Minutes	

Detailed instructions for Intenza 550ETXi—

STEP 1

Step on the Elliptical Trainer and begin pedaling.

STEP 2

Insert a USB device to the USB port if you want to save your program.

STEP 3

Choose **CUSTOM** by turning the Uni—Dial™ and press **ENTER** to confirm.

STEP 4

Choose **FILE NAME (SUNDAY—SATURDAY)** by turning the Uni—Dial™ and press **ENTER** to confirm.

STEP 5

Input your age, gender, weight.

STEP 6

Input the desired **WORKOUT TIME** by turning the Uni—Dial™ and press **ENTER** to confirm. The Elliptical will display a default time of 30 minutes. You may enter any time between 20 to 99 minutes.

STEP 7

During the workout, you can adjust speed. The workout data will be shown on message center under scan mode. Press **SCAN** to lock the workout data.

STEP 8

During the workout InZone™ will indicate your heart rate level.

STEP 9

To **PAUSE** the program, press **STOP** or stop pedaling. In pause mode, the timer will appear and countdown for 1 minute, the power will go off after 1 minute. You can pedal to restart the console within 1 minute.

STEP 10

Press **STOP**, to exit the program before reaching your workout goal or stop pedaling and allow pause timer to expire.

STEP 11

If you want to keep the workout profile in the USB, choose **YES** to save the workout profile.

PLEASE NOTE Users can adjust WARM UP and COOL DOWN time (1—99 mins) according to preference.

4.6 Race Program

The Race program offers a fun and challenging workout option.

You can compete against the previous champion which is saved in the system or your previous record from a USB. If you win the record in the system (the default champion), your record and name can be saved to the console system for the next challenger.

Also you can save your record to a USB. You can adjust the speed during the workout.

4.6.1 Intenza 550ETXe2

For 550ETXe2, you can see your racing status on the dashboard.

The highlighted runner represents the user and the background runner represents your competitor. BEHIND is the distance between you and your competitor, REMAIN means the distance to your target.

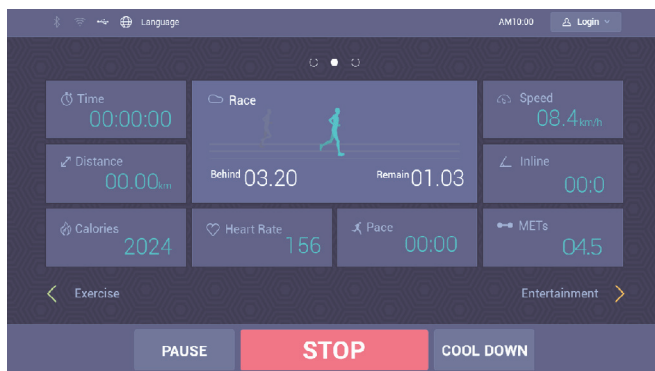

Workout procedure

STEP 1	STEP 2	STEP 3	STEP 4	STEP 5	STEP 6	STEP 7
RACE TYPE	COMPETITOR	WARM UP	START	RACE	COOL DOWN	SAVE THE RECORD
0.31 mi/500m	Computer	Pedaling 5 Minutes	Skip Warm Up	Duration	4 Minutes	Auto saving by USB
0.62 mi/1 km	Computer/ Customize	Pedaling 5 Minutes	Skip Warm Up	Duration	4 Minutes	Auto saving by USB/ Input Name To Console Memory
1.25 mi/2 km	Customize	Pedaling 5 Minutes	Skip Warm Up	Duration	4 Minutes	Input Name To Console Memory

4.6.1 Intenza 550ETXe2

Detailed instructions for Intenza 550ETXe2

STEP 1

Step on the Elliptical Trainer and begin pedaling.

STEP 2

Choose **RACE** by touching console screen.

STEP 3

Choose **MODE** (0.31MI/500M, 0.62MI/2KM, 1.25MI/2KM) by touching the console screen and press **↵** to confirm.

STEP 4

Select the competitor by touching console screen:

A Computer (Intenza system default): You can choose the records for **RACE MODE**.

B Custom: You can input customize record from 00:03:07 to 00:15:37.

STEP 5

Press **START** to start the workout, after you finish the **WARM UP**. You can adjust the pause time by touching **▲ ▼** to extend or shorten time.

STEP 6

When the **SPM** is below 40, the timer will appear for a 10 second countdown. You need to pedal faster in order to maintain 40 **SPM**, otherwise you will lose the race after countdown.

STEP 7

If you touch **COOL DOWN** mode the default is 4 minutes. You can adjust Cool down time (1—99 mins) according to preference. If you are no longer able to maintain the speed, press **STOP** to exit the workout.

STEP 8

Press **STOP** to exit the program before reaching your workout goal, stop pedaling or allow pause timer to expire.

STEP 9

Race result will be displayed in the profile window. You can save your name into the Intenza console system when you beat the last champion. You can save the racing record win, or lose, to your personal USB device.

4.6.2 Intenza 550ETXi

For the 550ETXi, once you choose the race distance, the race tracks will be displayed in the profile window.

The upper track represents the user, and the lower track represents your competitor. “S” on the left side stands for Start, and “G” on the right side stands for Goal. The tracks will display the racing status by flashing LED lights during your workout.



Workout procedure—

STEP 1	STEP 2	STEP 3	STEP 4	STEP 5	STEP 6	STEP 7
RACE TYPE	COMPETITOR	WARM UP	START	RACE	COOL DOWN	SAVE THE RECORD
0.31 mi/500m	USB User	Pedaling	Press Start	Duration	4 Minutes	Auto saving by USB
0.62 mi/1 km	USB User/ Champion	Pedaling	Press Start	Duration	4 Minutes	Auto saving by USB/ Input Name To Console Memory
1.25 mi/2 km	Champion	Pedaling	Press Start	Duration	4 Minutes	Input Name To Console Memory

4.6.2 Intenza 550ETXi

Detailed instructions for Intenza 550ETXi

STEP 1

Step on the Elliptical Trainer and begin pedaling.

STEP 2

Choose **RACE** by turning the Uni—Dial™ dial and press **ENTER** to confirm.

STEP 3

Choose **MODE** (0.31MI/500M, 0.62MI/2KM, 1.25MI/2KM) by turning the Uni—Dial™ and press **ENTER** to confirm.

STEP 4

Select the competitor by turning the Uni—Dial™

A Champion from Intenza system: • Choose Champion to compete with by turning the Uni—Dial™ and press **ENTER** to start.

B Your previous record from USB: • Insert the USB device to USB port.
• Choose USB to compete with by turning the Uni—Dial™ and press **ENTER** to start.

STEP 5

Press **ENTER** to start the workout, after you finish the **WARM UP**.

STEP 6

During the workout, **INZONE™** will indicate your heart rate condition.

STEP 7

During the workout, data will be displayed in the message bar under **SCAN** mode. Press **SCAN** to lock the workout data.

STEP 8

When the **SPM** is below 40, the timer will display a 10 second countdown. You need to pedal faster in order to maintain 40 **SPM**, otherwise you will lose the race after countdown.

STEP 9

The Elliptical Trainer will enter **COOL DOWN** mode for 4 minutes, when you finish the race.

STEP 10

Press **STOP** to exit the program before reaching your workout goal, stop pedaling or allow pause timer to expire.

STEP 11

Racing result will be displayed in the profile window. You can save your name into the Intenza console system when you beat the last champion. Additionally, you can save the racing record under win, or lose, to your personal USB device.

4.6.2 Intenza 550ETXi

Saving win record into Intenza system

STEP 1

By turning Uni-Dial™, select the letters to input your name and press ENTER.

STEP 2

During name editing, you can press BACK to correct any incorrect input.

STEP 3

After completing input, pause for 5 seconds, or press STOP then END will appear. Press ENTER to confirm.

Save racing win record into personal USB

STEP 1

Press STOP or ENTER to exit the summary mode.

STEP 2

Choose YES to confirm saving or NO to exit by turning the Uni-Dial™ and press ENTER to double confirm.

STEP 3

When the display shows SAVING COMPLETED, the process of saving is finished.

4.7 Fitness Test

VO₂ max technology is useful in measuring the ability of an individual to transport and utilize oxygen during exercise progression.

The test starts at a low speed and gradually increases in speed levels. The test will end when the user presses STOP. Use of a telemetry heart rate strap is optional but can transmit more data to the system during the test. Once you finish the test and recovery period (cool down), the workout result and scores will be displayed in the profile window. Refer to VO₂ MAX CHART to interpret your test score.

4.7.1 Intenza 550ETXe2

PLEASE NOTE Users can adjust Cool down time (1—99 mins) according to preference.

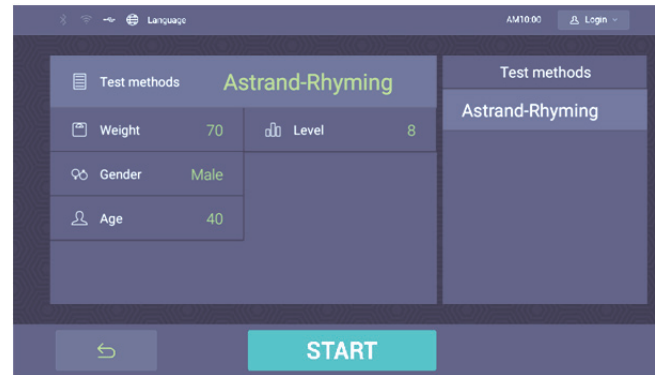

Workout procedure

STEP 1	STEP 2	STEP 3	STEP 4	STEP 5	STEP 6	STEP 7	STEP 8
AGE	GENDER	WEIGHT	LEVEL	WARM UP	START	TEST	COOL DOWN
Range: 10—99	Male Female	30—181 kg/ 70—400 lbs	1—40	0—5 minutes	Press Start	6 minutes	1—99 minutes

Detailed instructions for Intenza 550ETXe2

STEP 1

Step on the Elliptical Trainer and begin pedaling.

STEP 2

Choose **FITNESS TEST** by touching console screen.

STEP 3

Choose Fitness Test **WALK, RUN** or **IPPT** mode by touching console screen.

STEP 4

You will enter the **WARM UP** mode for 0—5 minutes after inputting your level. After warm up, your workout will start automatically.

STEP 5

During the Fitness Test Program, you must maintain a pedaling speed of 70 SPM. During the minutes of the test period, you can adjust the resistance level.

STEP 6

During the last 60 seconds hold onto the contact heart rate sensor.

STEP 7

Keep pedaling until you are no longer able to keep up with the speed. Once you fall below required 70 SPM, program will go into **COOL DOWN**.

STEP 8

If your HR is over 100% maximum, the test program will stop automatically for your personal safety.

STEP 9

Press **STOP** key, if you are not able to continue the workout.

4.7.2 Intenza 550ETXi

Workout procedure

STEP 1	STEP 2	STEP 3	STEP 4	STEP 5	STEP 6	STEP 7	STEP 8
AGE	GENDER	WEIGHT	LEVEL	WARM UP	START	TEST	COOL DOWN
Range: 10—99	Male Female	30—181kg / 70—400 lbs.	1—40	2 minutes	Press Start	6 minutes	4 minutes

Detailed instructions for Intenza 550ETXi

STEP 1

Step on the Elliptical Trainer and begin pedaling.

STEP 2

Choose **FITNESS TEST** by turning the Uni—Dial™ dial and press **ENTER** to confirm.

STEP 3

Input your **Age/Gender/Weight/Level** by turning Uni—Dial™ and press **ENTER** to confirm.

STEP 4

You will enter the **WARM UP** mode for 2 minutes after inputting your level. After 2 minutes of warm up time, your workout will start automatically.

STEP 5

During the Fitness Test Program, you must maintain a pedaling speed of 70 **SPM**. During the minutes of the test period, you can adjust the resistance level.

STEP 6

During the last 60 seconds hold onto the contact heart rate sensor.

STEP 7

During the workout, **INZONE™** will indicate your condition of heart rate.

STEP 8

During workout, data will be displayed in the message center under **SCAN** mode. Press **SCAN** to lock the workout data..

STEP 9

Keep pedaling until you are no longer able to keep up with the speed. Once you fall below required 70 **SPM**, program will go into **COOL DOWN** for 4 minutes.

STEP 10

For safety reason, when your **HR** goes over 100% maximum, the test program will stop automatically.

STEP 11

Press **STOP** key, if you are not able to continue the workout.

V_O2 Max Chart

Male (Values in ml/kg/min)

AGE	VERY POOR	POOR	FAIR	GOOD	EXCELLENT	SUPERIOR
13-19	<35.0	35.0-38.3	38.4-45.1	45.2-50.9	51.0-55.9	>55.9
20-29	<33.0	33.0-36.4	36.5-42.4	42.5-46.4	46.5-52.4	>52.4
30-39	<31.5	31.5-35.4	35.5-40.9	41.0-44.9	45.0-49.4	>49.4
40-49	<30.2	30.2-33.5	33.6-38.9	39.0-43.7	43.8-48.0	>48.0
50-59	<26.1	26.1-30.9	31.0-35.7	35.8-40.9	41.0-45.3	>45.3
60+	<20.5	20.5-26.0	26.1-32.2	32.3-36.4	36.5-44.2	>44.2

Female (Values in ml/kg/min)

AGE	VERY POOR	POOR	FAIR	GOOD	EXCELLENT	SUPERIOR
13-19	<25.0	25.0-30.9	31.0-34.9	35.0-38.9	39.0-41.9	>41.9
20-29	<23.6	23.6-28.9	29.0-32.9	33.0-36.9	37.0-41.0	>41.0
30-39	<22.8	22.8-26.9	27.0-31.4	31.5-35.6	35.7-40.0	>40.0
40-49	<21.0	21.0-24.4	24.5-28.9	29.0-32.8	32.9-36.9	>36.9
50-59	<20.2	20.2-22.7	22.8-26.9	27.0-31.4	31.5-35.7	>35.7
60+	<17.5	17.5-20.1	20.2-24.4	24.5-30.2	30.3-31.4	>31.4

5. Maintenance.

5.1 Preventative Maintenance Tips

With durable, high performance components, the Intenza 550 Series Elliptical Trainer is designed for commercial health club usage with minimal maintenance required.

WARNING

- The safety level of the equipment can be maintained only if it is examined regularly for damage and wear, e.g. connection points.
- Replace defective components immediately and/or keep the equipment out of use until repair.

To keep your Intenza 550 Series Elliptical working properly, Intenza strongly recommends performing daily, and regularly scheduled, preventative maintenance measures as outlined below.

DAILY MAINTENANCE

Locate the product in a dry, cool place.

Before and after each exercise session, ensure the area around the Intenza 550 Series Elliptical is free of obstacles and any clutter that may interfere with Intenza 550 Series Elliptical operation.

Remove excessive accumulations of dust, dirt, and other substances by using a clean, soft cloth and a non—abrasive liquid cleaner.

Wipe down the exterior of the console, stick shift, handlebars and contact heart rate grips.

Avoid getting extra moisture on the console. Keeping the console free of fingerprints and sweat will extend its lifespan.

Never use ammonia, acid—based, or petroleum—based solvents on any surface area of the Intenza 550 Series Elliptical as it may damage Intenza products.

Do not spray cleaning liquid onto the display screen or heart rate grips.

REGULAR MAINTENANCE

Inspect the console mounting screws for security, and retighten if necessary.

Inspect the display panel keypads for wear and tear.

Check that the pedals and shrouds are secure.

Clean the ramp tracks.

5.2 Self Diagnosis

Your Service Representative may need to check accumulated data about the past usage of your Elliptical Trainer, test the function and check for error messages.

For these reasons, the Intenza 550 Series Elliptical is equipped with a service mode which has diagnostic reports that can assist with troubleshooting. InCare™ Online function is a service diagnostic process that can automatically send out detected error message to Intenza customer service. For more information about self diagnosis, please contact your local dealer or refer to the service manual.

5.3 550ETXi Series: How to Charge The Battery

Intenza 550ETXi is equipped with a generator and rechargeable battery to provide constant power.

Upon initial use (or after a prolonged storage period) the battery may require charging before achieving maximum capacity. There is no need to charge the equipment's battery for normal and frequent use. The console will display **CHARGE THE BATTERY** when the battery voltage is low.

CHARGE BY GENERATOR

During normal daily use the power generated by your workout will keep the battery charged.

CHARGE BY EXTERNAL POWER

An optional power adaptor can be purchased and provides constant power to the equipment. A 19V/2.1A type of adaptor is required to charge the battery. To purchase the optional power adaptor, check with your local dealer.

5.4 550ETXi Series: Recycling The Battery

When no longer useful, this equipment and/or its battery must be recycled, or disposed of, according to your local, or national, recycling regulations.

To remove the battery, disassemble the bottom front cover by using a 4mm screwdriver, then disconnect the cables.

6. Troubleshooting.

6.1 When To Call For Help

PLEASE NOTE Replace defective components immediately or remove the equipment from use until it is repaired.

CHECKLIST

- Verify the symptom and review the operating instructions.
- The problem may be unfamiliarity with the product, its features or the workout programs.
- Check the error message, then follow the instructions in the service manual.
- When the display shows **NEED MAINTENANCE**, it is suggested to contact your local distributor for service immediately.
- If the problem you encounter has not been solved by the above steps, and the Intenza 550 Series Elliptical is still not operational, locate and document the unit serial number and contact your local dealer.
- Send the diagnosis report (Please refer to Section 5.2 Self Diagnosis for more information) and serial number to your local distributor for service.

WHERE IS THE PRODUCT SERIAL NUMBER

.....
The serial number contains six digits, and there are two locations you can find the Intenza 550 Series Elliptical serial number:

- One is located on the front of the Intenza 550 Series Elliptical, near the power switch.
- One is located on the front post.



6.2 Error Message

When the display shows error message, please contact your local Authorized Dealer or Service Center.

7. Exploded Drawings, Parts List And Specifications.

7.1 Intenza 550ETXe2 Elliptical Exploded Drawing And Parts List

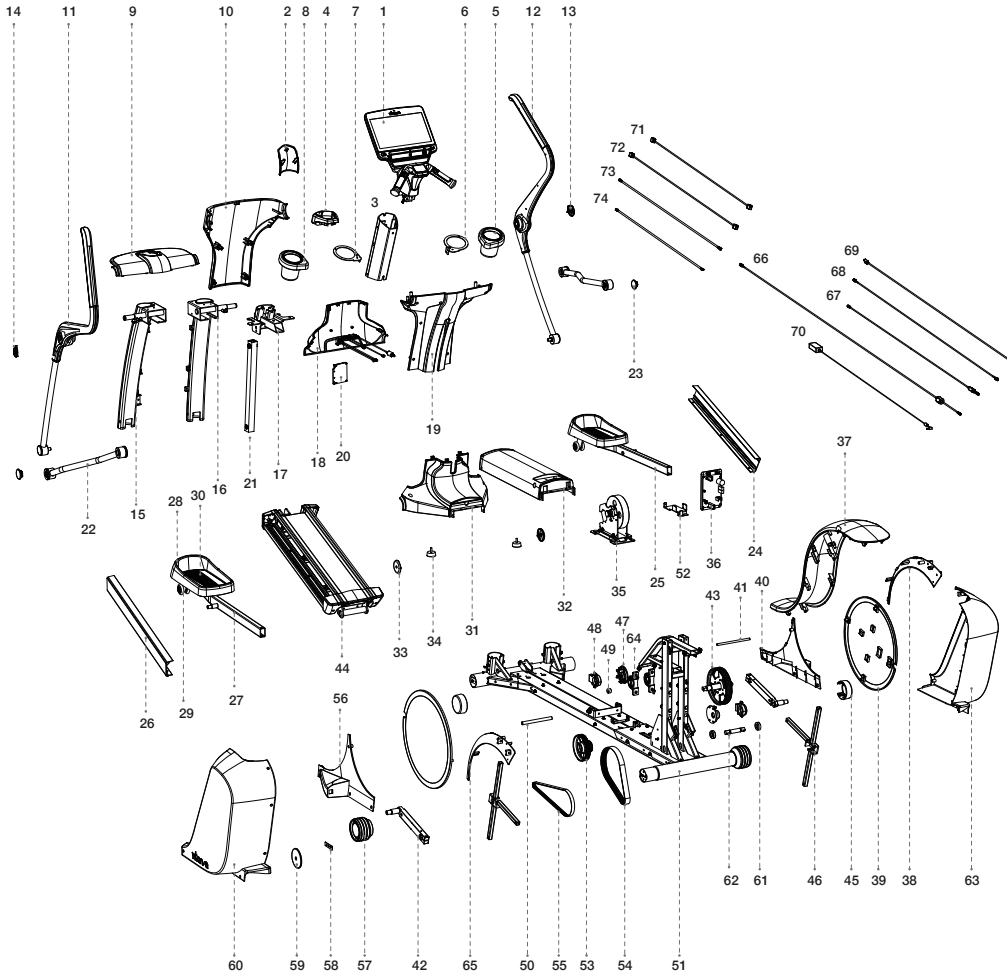

NO	ITEM	NO	ITEM	NO	ITEM
1	Console, w/handle	31	Cover, upright, rear, btm	61	Bearing, ball, 6004ZZ
2	Cover, console, mount, btm	32	Cover, upright, rear, top, inj	62	Shaft, pulley, step—up
3	Post, upright	33	Cap, stabilizer	63	Cover, side, top, R
4	Cover, upright	34	Foot, adjustable	64	Bearing, pillow block
5	Holder, bottle	35	Generator, w/bracket	65	Cover, rear, inside, L
6	Bracket, holder, bottle, R	36	LCB, w/heatsink	66	Cable, signal, frame, w/core
7	Bracket, holder, bottle, L	37	Cover, rear, top, injection	67	Cable, TV
8	Holder, bottle	38	Cover, rear, inside, R	68	Cable, LCB, frame + core
9	Cover, upright, top	39	Cover, crankarm	69	Cable, HDMI
10	Cover, upright, front, top	40	Cover, side, bottom, R, inj	70	Adaptor, 12V
11	Handlebar, L	41	Tube, fix, cover	71	Cable, connect, frame, RJ45
12	Handlebar, R	42	Crankarm, coated	72	Cable, connect, frame
13	Decal, bug, handlebar, R	43	Pulley, input, w/shaft	73	Cable, generator, power input
14	Decal, bug, handlebar, L	44	Ramp	74	Cable, hybrid, torque control
15	Post, upright, L, coated	45	Cover, linkarm		
16	Post, upright, R, coated	46	Cross, coated		
17	Mount, post, top, coated	47	Cover, stairarm, injection		
18	Cover, upright, btm, w/cable	48	Block, pivot, stairarm		
19	Cover, upright, rear, top	49	Bearing		
20	PCB, w/heatsink	50	Shaft, ramp		
21	Tube, fixramp, coating	51	Frame, main, coated		
22	Linkarm	52	Bracket, battery		
23	Cover, pivot, linkarm	53	Pulley, step—up		
24	Coating, cover, ramp, side	54	Belt, drive		
25	Stairarm, R, coated	55	Belt, drive		
26	Coating, cover, ramp, side	56	Cover, side, bottom, L w/clip		
27	Stairarm, L, coated	57	Wheel, moving		
28	Cover, pedal	58	Bracket, wheel		
29	Wheel, w/bearing	59	Cap, wheel		
30	Sheet, pedal	60	Cover, side, top, L		

7.1 Intenza 550ETXe2 Elliptical Exploded Drawing And Parts List

Specifications: Intenza 550ETXe2 Elliptical

Design Use	Commercial
Maximum User Weight	181kgs/400 lbs
Step Up Height	35 cm (13.7 in)
Stride Length	52—55 cm (20.4—21.6 in)
Pedal to pedal distance	6 cm (2.3 in)

CONSOLE

Type	16" TFT capacitance touch screen monitor
Display	Heart rate, Pace, Time, METs, Calories, Distance, Speed, Intensity
Language	20 countries, 20 Languages— Arabic, Dutch, English (UK English), English (US English), Finnish, French, German, Hungarian, Japanese, Korean, Persian, Polish, Portuguese, Russian, Spanish, Simplified Chinese, Traditional Chinese, Turkish, Lithuanian, Italian
Summaries	Total elapsed time of workout, total calories burned, total distance, total METs generated, heart rate profile record
Workout	Quick start, Preset programs, Target programs, Heart rate programs, Custom programs, Race programs, Fitness test
Heart rate monitor	Polar telemetry heart rate monitoring system

ASSEMBLY DIMENSIONS		
DIMENSION	550ETXe2	
LENGTH	2,090 mm	83 inches
WIDTH	840 mm	33 inches
HEIGHT	1,720 mm	66 inches
WEIGHT	192 kgs	423 lbs

SHIPPING DIMENSIONS		
DIMENSION	550ETXe2	
LENGTH	2,200 mm	87 inches
WIDTH	780 mm	31 inches
HEIGHT	100 mm	39 inches
WEIGHT	248 kgs	547 lbs

7.2 Intenza 550ETXi Elliptical Exploded Drawing And Parts List

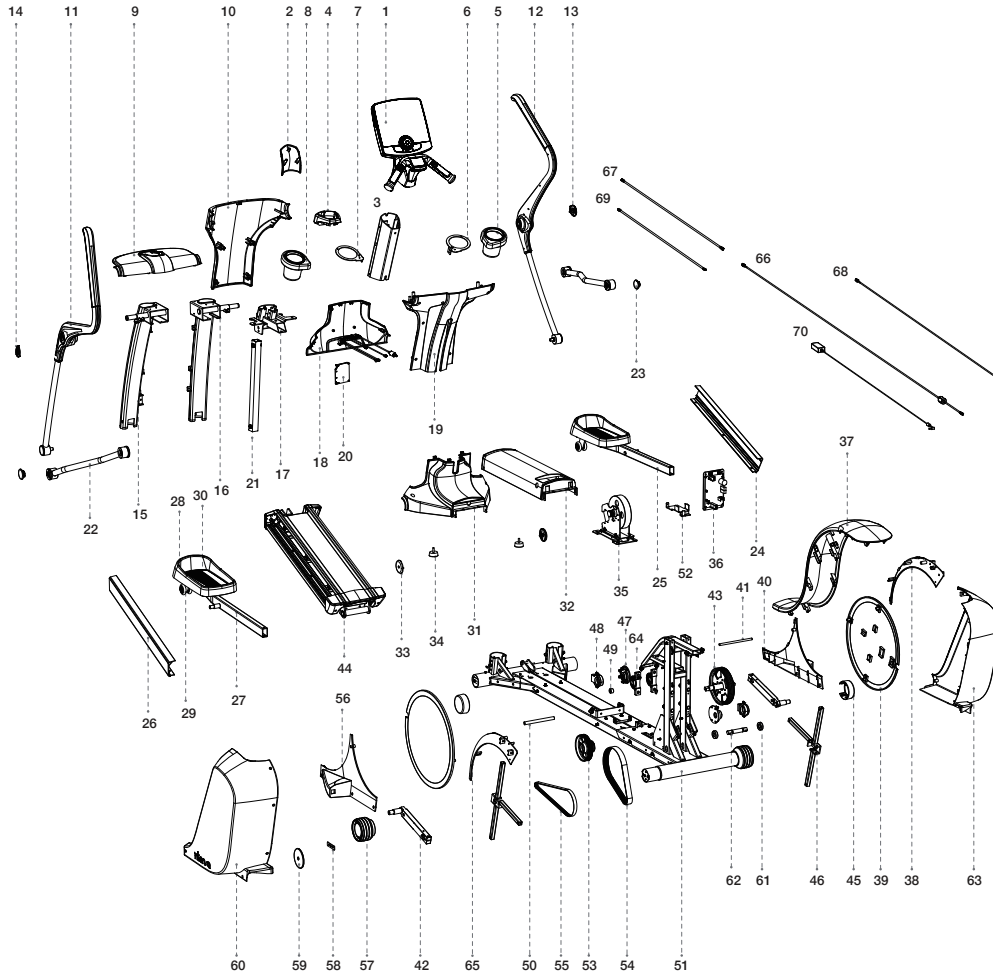

NO	ITEM	NO	ITEM	NO	ITEM
1	Console, w/handle	31	Cover, upright, rear, btm	61	Bearing, ball, 6004ZZ
2	Cover, console, mount, btm	32	Cover, upright, rear, top, inj	62	Shaft, pulley, step-up
3	Post, upright	33	Cap, stabilizer	63	Cover, side, top, R
4	Cover, upright	34	Foot, adjustable	64	Bearing, pillow block
5	Holder, bottle	35	Generator, w/bracket	65	Cover, rear, inside, L
6	Bracket, holder, bottle, R	36	LCB, w/heatsink	66	Cable, signal, frame, w/core
7	Bracket, holder, bottle, L	37	Cover, rear, top, injection	67	Cable, generator, power input
8	Holder, bottle	38	Cover, rear, inside, R	68	Cable, LCB, frame + core
9	Cover, upright, top	39	Cover, crankarm	69	Cable, hybrid, torque control
10	Cover, upright, front, top	40	Cover, side, bottom, R, inj	70	Adaptor, 19V
11	Handlebar, L	41	Tube, fix, cover		
12	Handlebar, R	42	Crankarm, coated		
13	Decal, bug, handlebar, R	43	Pulley, input, w/shaft		
14	Decal, bug, handlebar, L	44	Ramp		
15	Post, upright, L, coated	45	Cover, linkarm		
16	Post, upright, R, coated	46	Cross, coated		
17	Mount, post, top, coated	47	Cover, stairarm, injection		
18	Cover, upright, btm, w/cable	48	Block, pivot, stairarm		
19	Cover, upright, rear, top	49	Bearing		
20	PCB, w/heatsink	50	Shaft, ramp		
21	Tube, fixramp, coating	51	Frame, main, coated		
22	Linkarm	52	Bracket, battery		
23	Cover, pivot, linkarm	53	Pulley, step-up		
24	Coating, cover, ramp, side	54	Belt, drive		
25	Stairarm, R, coated	55	Belt, drive		
26	Coating, cover, ramp, side	56	Cover, side, bottom, L w/clip		
27	Stairarm, L, coated	57	Wheel, moving		
28	Cover, pedal	58	Bracket, wheel		
29	Wheel, w/bearing	59	Cap, wheel		
30	Sheet, pedal	60	Cover, side, top, L		

7.2 Intenza 550ETXi Elliptical Exploded Drawing And Parts List

Specifications: Intenza 550ETXi Elliptical

Design Use	Commercial
Maximum User Weight	181kgs/400 lbs
Step Up Height	35 cm (13.7 in)
Stride Length	52—55 cm (20.4—21.6 in)
Pedal to pedal distance	6 cm (2.3 in)

CONSOLE

Type	LED display
Display	Heart rate, Level, SPM, Calories, Watts, Distance, Speed
Summaries	Total elapsed time of workout, total calories burned, total distance, total METs generated, heart rate profile record
Workout	Quick start, Preset programs, Target programs, Heart rate programs, Custom programs, Race programs, Fitness test
Heart rate monitor	Polar telemetry heart rate monitoring system

ASSEMBLY DIMENSIONS		
DIMENSION	550ETXi	
LENGTH	2,090 mm	83 inches
WIDTH	840 mm	33 inches
HEIGHT	1,720 mm	66 inches
WEIGHT	188 kgs	414 lbs

SHIPPING DIMENSIONS		
DIMENSION	550ETXi	
LENGTH	2,200 mm	87 inches
WIDTH	780 mm	31 inches
HEIGHT	100 mm	39 inches
WEIGHT	244 kgs	537 lbs

© 2018 HealthStream Taiwan Inc.

No.28, Jiaotuzai Boulevard, Liuying District, Tainan City 736, Taiwan

intenzafitness.com

Printed in Taiwan

X001144
Version—1.2



DESIGNED, ENGINEERED AND BUILT IN TAIWAN
intenzafitness.com

